

## Investigation of the piezoelectric thimble tactile device operating modes

RAMUTIS BANSEVICIUS<sup>1</sup>, EGIDIJUS DRAGASIUS<sup>2</sup>, VYTAUTAS GRIGAS<sup>3\*</sup>,  
VYTAUTAS JURENAS<sup>1</sup>, DARIUS MAZEIKA<sup>1</sup>, ARUNAS ZVIRONAS<sup>1</sup>

<sup>1</sup> Institute of Mechatronics, Kaunas University of Technology, Kaunas, Lithuania.

<sup>2</sup> Department of Production Engineering, Kaunas University of Technology, Kaunas, Lithuania.

<sup>3</sup> Department of Mechanical Engineering, Kaunas University of Technology, Kaunas, Lithuania.

A multifunctional device to transfer graphical or text information for blind or visually impaired is presented. The prototype using tactile perception has been designed where information displayed on the screen of electronic device (mobile phone, PC) is transferred by oscillating needle, touching the fingertip. Having the aim to define optimal parameters of the fingertip excitation by needle, the computational analysis of different excitation modes has been carried out. A 3D solid computational finite element model of the skin segment, comprising four main fingertip skin layers (stratum corneum, epidermis, dermis and hypodermis) was built by using ANSYS Workbench FEA software. Harmonic analysis of its stress-strain state under excitation with different frequency (up to 10000 Hz) and harmonic force (0.01 N), acting outer stratum corneum layer in normal direction at one, two or three points has been performed. The influence of the mode of dynamic loading of skin was evaluated (in terms of the tactile signal level) on the basis of the normal and shear elastic strain in dermis, where mechanoreceptors are placed. It is shown that the tactile perception of information, delivered by three vibrating pins, may be influenced by configuration of excitation points (their number and phase of loading) and the frequency of excitation.

*Key words: tactile sensation, skin strain, harmonic excitation, finite element analysis*

### 1. Introduction

A lot of various applications exist today for blind and visually impaired: acoustic signal generators and special ground markers near road (zebra crossing), special ground markers near dangerous spaces, Braille texts and special marks (raised printing) on the banknotes, blind people sticks, etc. Furthermore, there is an increasing need to ensure blind or visually impaired to be able to use modern technologies: television, computers, mobile phones and a lot of other devices, which help share information and make life more comfortable. First generation devices, helping to transfer information for blind people, were inconvenient: they were big and clumsy, uncomfortable and not

mobile. In addition, they were mostly dedicated to transfer only textual information. So to ensure their up-to-date functionality (size and mass parameters, simplicity, universality, etc.), the attempts to create more sophisticated equipment started. For example, a novel computer mouse was designed and patented [1] and its testing started [2], [3], but it was dedicated to computers controlled by mouse.

Such systems are not suitable for compact modern devices as smartphones, PDA's, etc., where even more compact and light devices should be employed. Again, they often may be materialized only by employment of modern technologies, for example, piezoelectric materials. Piezoelectric actuators are widely used in different fields of modern engineering, from microscopes to systems for positioning objects with extreme accuracy.

---

\* Corresponding author: Vytautas Grigas, Department of Mechanical Engineering, Kaunas University of Technology, Studentų str. 56-344, LT-51424 Kaunas, Lithuania. Tel: +370-37-204796, e-mail: vytautas.grigas@ktu.lt

Received: February 6th, 2014

Accepted for publication: March 18th, 2014

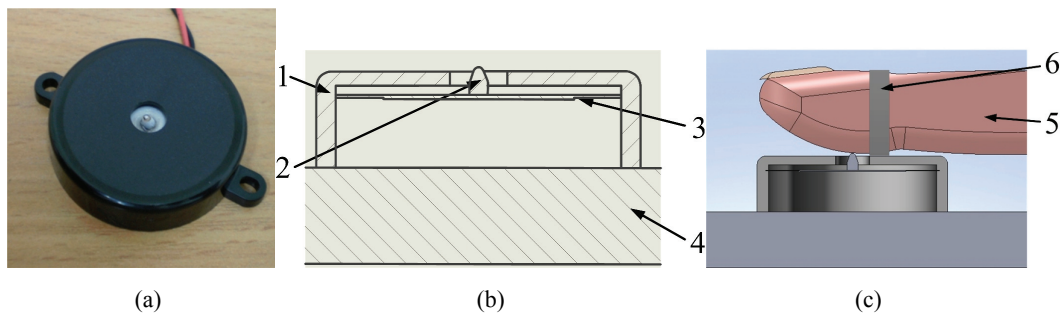

Fig. 1. Piezoelectric tactile device: (a) photo, (b) cross section scheme, (c) 3D model.  
1 – body, 2 – needle, 3 – piezoelectric disc actuator, 4 – PC screen, 5 – finger, 6 – rubber ring [1]

A lot of such various purpose devices were developed in Kaunas University of Technology, including multi-functional tactile devices to convey graphical or text information for blind person [4].

The piezoelectric thimble under research consists of piezoelectric disk actuator with a tactile pin – needle in its center, assembled into a hollow disk shaped body (Fig. 1a, b). It can be positioned on a blind person's fingertip with the help of the rubber ring, so that the skin is always in contact with the needle (Fig. 1c). The information about the environment (for example, taken from PC or phone screen) can be transmitted by oscillating needle, which affects the fingertip skin.

The oscillations of the needle in normal direction to the skin surface are excited by piezoelectric actuator, connected to signal generator controlled by processor, responding to the information displayed on the screen of the device in the zone where the finger with thimble touches it. Because of a huge variety of the types of information, displayed on the screen of the device (text, graphics, color, etc.) a lot of regimes of fingertip skin excitation should be used to ensure functionality of the device. Thus the computational research of the fingertip skin–actuator pin interaction has been initiated having the aim to verify the influence of the mode of dynamic loading (frequency of excitation and the number of pins actuated in different phases) on the tactile signal level, which is evaluated by the intensity of normal and shear elastic strain in dermis, where mechanoreceptors sensing normal and shear loading of the skin are placed.

## 2 Materials and method

With the aim to define optimal parameters of the fingertip excitation by needle (frequency of excitation, number and combination of active needles, etc.), a numerical simulation of piezoelectric thimble

needle–fingertip skin dynamic interaction at different excitation modes has been carried out.

Human skin is a multi-layered structure consisting of layers of epidermis, dermis and hypodermis (Fig. 2, [5]–[8]), having quite different material properties, with mechanoreceptors reacting to the tactile signals, affecting it. It is considered that mechanoreceptors react to the normal and shear deformations (strain), arising in skin around them. Meissner receptors (located at the junction of dermis and epidermis) sense the normal loading, and Ruffini receptors (located in the midst-top layers of dermis) are responsible for the shear sensing [7], [9]. Thus the response to a given stimulus depends on the mechanical properties of the skin and parameters of excitation.

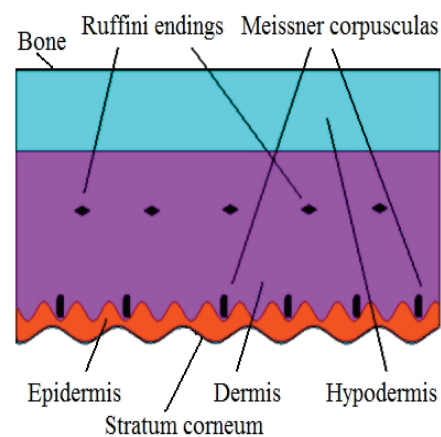

Fig. 2. Human skin structure

The proposed tactile device for modeling requires some specific data, namely – about the reaction of the fingertip skin to vibrational excitation of its outer layer (stratum corneum) surface. In the case described the configuration (number and location) of the operator's fingertip excitation points and the frequency of the excitation have had to be evaluated.

Two types of problems were solved during numerical investigation of fingertip skin:

- static structural analysis of the skin affected by reference force (serves for proving the correctness of computational model);
- dynamic analysis of the skin segment – harmonic response analysis showing the strain state of the skin, arising under different modes of the harmonic excitation).

The computational finite element model of the skin was built and the investigation was performed by the finite element analysis system ANSYS Workbench 14.0. The simplified 3D solid geometrical model of the human finger skin segment (15 mm length, 10 mm width, 6.0 mm thickness) was created (Fig. 3) with no external and internal, interlayer, ridges [6]. It consists of four rectangular parallelepiped shaped layers: total 0.2 mm thick epidermis layer (including 0.015 mm thick stratum corneum (external, tectorial) layer), 1.3 mm dermis and 4.5 mm upper, hypodermis (or subcutaneous tissue) layer. Three circle shaped areas of 1.0 mm in diameter (one in the middle of the lower surface and two at a 2 mm distance from it along the longer side of the model) for applying excitation were demarcated. It should be noted that the eventual size of the model, used for computations was defined after several attempts with smaller models, which gave quite unstable results. The measurements of skin segment were increased insomuch that the results of computations become practically independent of the size of model.

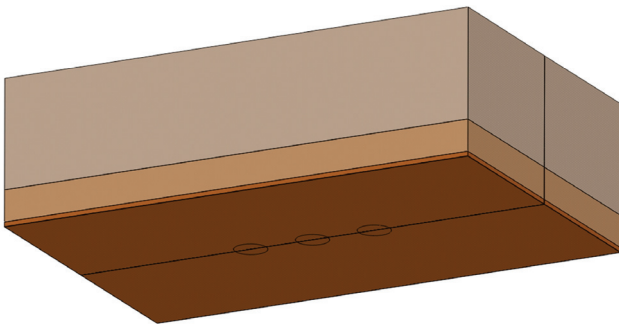

Fig. 3. Geometric model of the skin segment

On the basis of geometrical model two computational finite element models were built, representing one half of geometric model described above (each consisting of approximately 15000 tetrahedral (8-Node Structural Solid) SOLID186 type finite elements (~40000 nodes) having size from 0.05 to 1 mm (depending on layer thickness, Fig. 4). Mechanical properties of the appropriate skin layers [6]–[8] are listed in Table 1. For both static and harmonic response analysis, a linear elastic description of material properties of skin layers was used because of very small

excitation signal level. In both cases the same boundary conditions (fixation) were used. Hypodermis layer was fixed immovably (“Fixed Support” boundary condition, restraining all degrees of freedom of nodes), and the side plain surfaces of all 4 layers, lying on the symmetry plane of the model, were restrained by using “Frictionless support” boundary condition. It allowed movement of nodes only in the symmetry plane, therewith allowing deformations of the whole model only in direction normal to the skin surface. In this way the presence of the same material at the other side of the symmetry plane was simulated, thus giving adequate results of computation employing smaller model and simplifying representation of the results of computations.

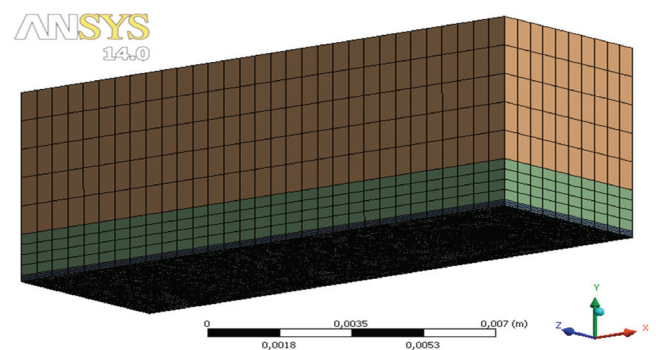

Fig. 4. Finite element model of the skin segment

Computational model for the static structural analysis of the skin, “indented” by a 1 mm diameter round cross-section pin, was supplied by static force, acting the middle semi-circular area at the bottom surface of stratum corneum layer of the model at normal direction (Fig. 5).

Six computational models for the dynamic harmonic analysis were built, differing in the number, location and phase of excitation force of the same size and frequency, corresponding to the following types of excitation of the fingertip skin by three tactile device pins (Fig. 5). A three number coding system is used for identifying the type of excitation, where the “0” means the absence of excitation on the corresponding pin, “1” – normal phase excitation, and “-1” – 180° phase (inverse direction) excitation:

1. Single pin (excitation applied to semi-circular area at the center of the model) (code 010);
2. Two adjacent pins (center and the left semi-circular areas) synchronically (code 110);
3. Three adjacent pins (all three semi-circular areas) synchronically (code 111);
4. Two outermost pins (both outermost semi-circular areas) synchronically (code 101);

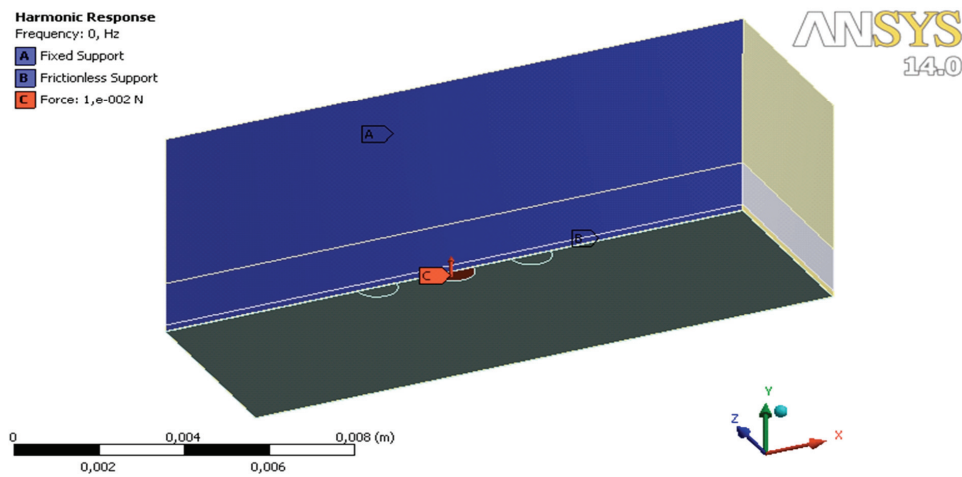

Fig. 5. Computational model of skin segment for static and dynamic (harmonic) structural analysis

5. All three pins (all three semi-circular areas), but the middle one with a  $180^\circ$  phase (inverse direction) (code 1-11);
6. Two outermost pins (both outermost semi-circular areas), but the right one with a  $180^\circ$  phase (inverse direction) with regard to left one (code 10-1).

### 3. Results of computations

A linear static structural analysis of the fingertip skin affected by static force, acting in normal direction, has been performed considering the fact that a human being senses 0.1–0.2 mm skin movement on the finger surface [10]. Thus the size of force, inducing such a deformation of the skin surface, had to be established as well as the level of shear and normal strain, induced in dermis layer, containing Ruffini and Meissner receptors. The simple variational solution showed that the 0.01 N size force ensures situation mentioned above (0.2 mm displacement of fingertip skin surface) (Fig. 6). The shape and

the depth of indentation are quite similar to the results observable by simple experiments, thus validating the computational model. Maximum level of normal (vertical,  $Y$  direction) strain in the dermis reaches 0.1726, and the maximum shear strain (horizontal,  $XZ$  plane) – 0.0535 (both – on the bottom surface of dermis layer directly above the indenter). Taking into account that increment of intensity of excitation force will lead to enlargement of size and correspondingly – power consumption of the piezoelectric thimble, namely this size of excitation force was used for further investigation.

The evaluation of the influence of regimes of skin excitation by pins upon the fingertip skin tactile perception is performed by means of comparative harmonic dynamic analysis of the stress-strain state of the model, representing fingertip skin segment, effected by harmonically varying force (amplitude 0.01 N and frequency up to 10000 Hz, with a step of 250 Hz), acting at the zones of location of three pins of tactile device. Damping during dynamic analysis was specified as “Constant (modal) Damping Ratio”, equal to 0.3 [7]. The magnitude and character of normal and

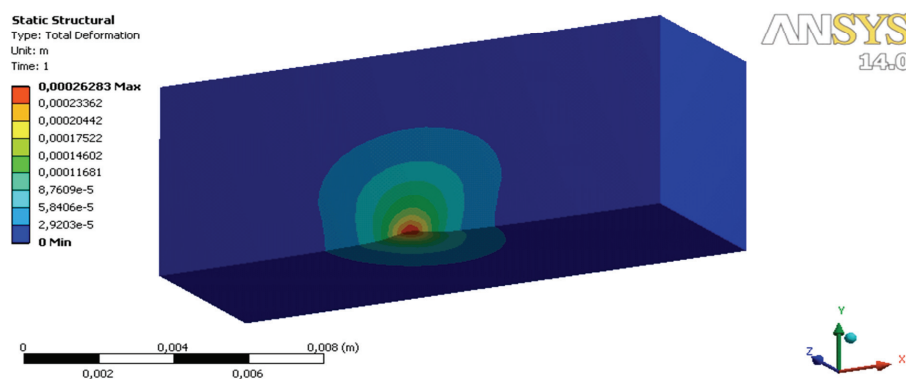

Fig. 6. Distribution of total deformations (displacements) of skin segment under 0.01 N static load in the center pin location

shear elastic strain distribution in the skin and their variation, depending on frequency of excitation, were obtained (Figs. 7–9).

It can be seen that in all cases of loading (number and location of “pins”, exciting the skin) the intensity of shear strain (both minimal and maximal values) in dermis is the highest ( $\sim\pm 1.5\text{--}5\%$ ), when frequency of excitation is the lowest (in the range from 250 to 2000 Hz). Further increment of frequency leads to the drop of maximal values of strain nearly two times (up to  $\sim\pm 0.5\text{--}2.5\%$ ), when frequency is from 4000 to 10000 Hz.

The normal strain in dermis depends on frequency of excitation in a more complicated way: when the excitation of skin fits two “pins” moving inversely, maximal and minimal normal strain curves are similar to shear strain (maximal values up to  $\sim\pm 15\%$  at lowest frequencies and later drop to  $\sim\pm 4\%$ ). But synchronic excitation (the same phase for all “pins”) gives the highest maximal strain level in the middle range of excitation frequencies, around the 6000 Hz ( $\sim\pm 3\text{--}4\%$ ), whereas the minimal normal strain is more significant at the beginning of excitation frequency range and later drops even more noticeably than shear strain – from  $\sim 5\text{--}7\%$  to near 1%.

In all the cases of excitation (combination of excitation points and frequencies), the zones where shear strain takes its maximal and minimal values, are located in the bottom plane of dermis layer, that is below the zone of location of Ruffini receptors, responsible for shear perception. In addition, each point of excitation is surrounded by one minimal and one maximal strain zones (see Fig. 7). Numbers of zones with maximal and minimal normal strain (sensed by Meissner receptors, placed in the dermis near the junction with epidermis) also depend on the number of excitation points. In this case, their location vary more significantly with frequency, moving from the bottom surface of dermis to the surface lying on vertical symmetry plane (Fig. 8), when the excitation is

synchronic (inverse phase excitation leads to location of maximal and minimal normal strain zone on the bottom plane of dermis layer).

The dependences of maximal level of strain on frequency of excitation (Fig. 9) show also that almost twice as large strains (both normal and shear) are obtained when inverse phase excitation of two or three points is applied to the skin normal. The shear strain also reaches its maximum when skin is excited by single point loading. This leads to the conclusion that the number of excitation points itself has no serious influence on the intensity of induced strain, but due to the fact that the location and size of the area of higher strain and differences in their shape vary depending on the number of excitation points and phases of excitation this factor may be elaborated during further development of the device as well as the intensity of excitation, which in the case described was set to minimum perceptible level. In latter case it is possible to maintain even without deeper analysis that the increment of excitation intensity will lead to better perception due to higher level of strain of the skin, thus the evaluation of the influence of location and size of the maximum strain zones on the skin sensibility should be evaluated experimentally.

It should be noted that depending on the mechanical properties of the particular human the results of analysis may differ quantitatively. Also it could be mentioned that the analysis performed carries comparative character, which allows the comparison of results of computations not taking into account the estimation errors, because the same model and same material properties are used in all cases.

Summarizing the results of harmonic response analysis of the 3D model of human fingertip skin segment model, the following conclusions may be done:

- the magnitude and distribution of shear and normal elastic strain in the skin under harmonic excitation vary significantly depending on frequency of excita-

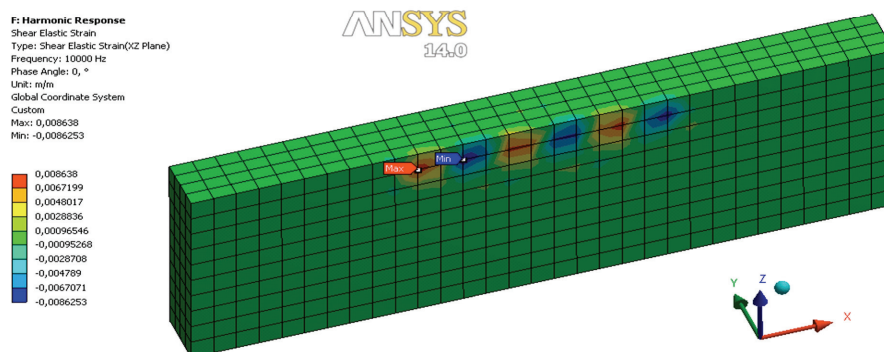

Fig. 7. Distribution of shear elastic strain (horizontal, XZ plane) in the dermis layer of skin segment up to 10000 Hz and 0.01 N harmonic force, loading in all the three pin locations (code of excitation 111)

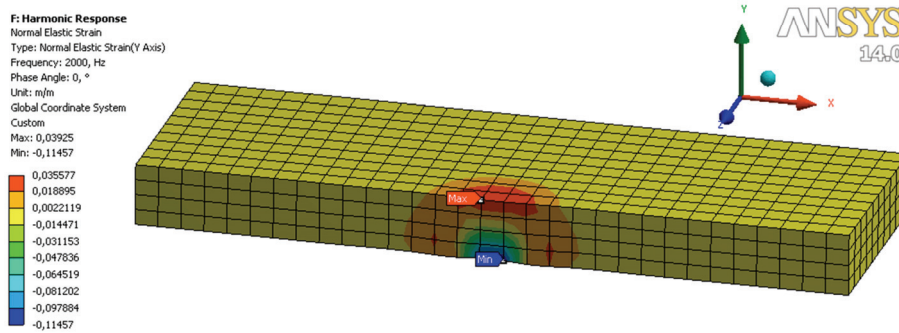

Fig. 8. Distribution of normal elastic strain (vertical, Y axis) in the dermis layer of skin segment up to 2000 Hz and 0.01 N harmonic force loading in the center pin location (code of excitation 010)]

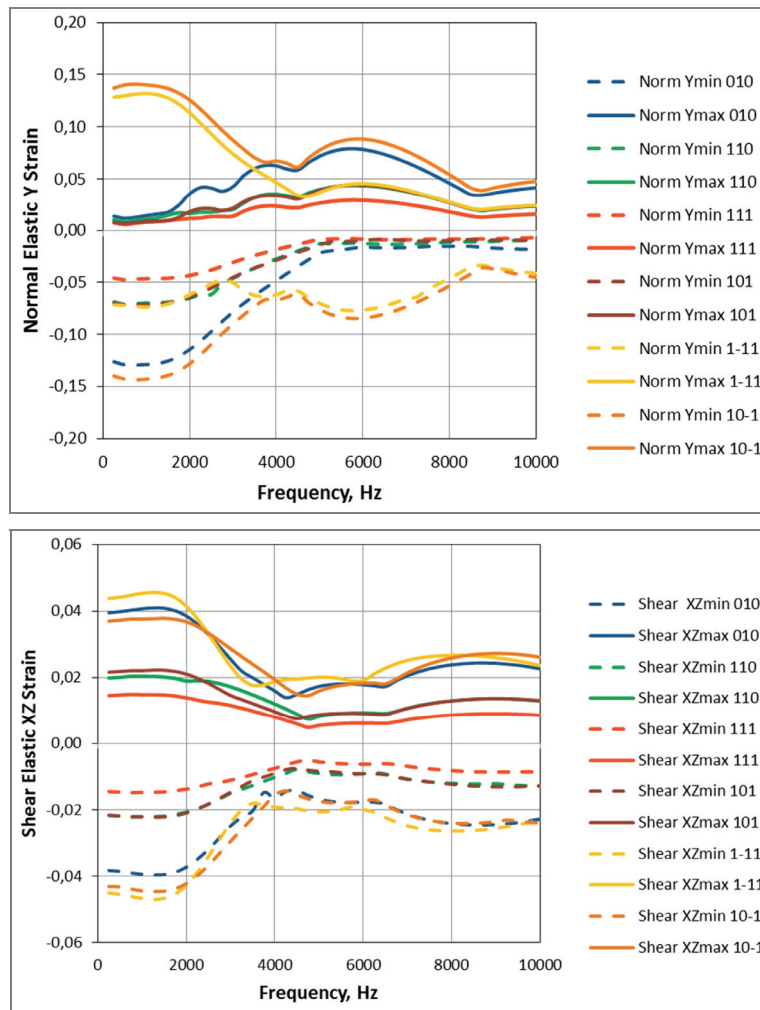

Fig. 9. The dependences of maximal values of the elastic strain in dermis on frequency of excitation: (a) normal strain (Y direction); (b) shear strain (XZ plane).

Solid lines represent maximal strain, dotted – minimal, colours of minimal and maximal strain curves for each case are the same

- tion (shear strain – from  $\approx \pm 0.5\%$  to  $2.5\%$ , normal – from  $\approx \pm 15\%$  to near  $1\%$ );
- in most cases maximal strains are obtained with lower frequencies of excitation (250–4000 Hz);
- number of maximal and minimal strain zones depend on number of excitation points;
- maximal and minimal shear strain zones are located in the bottom plane of dermis layer;
- location of zones with maximal and minimal normal strain vary more significantly with frequency, moving from bottom surface of dermis to its middle or even top surface.

It can be stated that the tactile perception of information, delivered by three vibrating pins, in tactile device may be influenced by configuration of excitation points (their number and phase of loading) and the frequency of excitation.

## 4. Discussion

Aspiration in helping to improve the quality of life of the blind and visually impaired lead up to design and development of a wide variety of devices delivering to individuals information about surroundings. Most interesting approaches are described below.

“The Forehead Retina” system observes 3D environment by video camera mounted on sunglasses. Information from camera is analyzed by computer and converted to signals activating 512 electrodes affecting forehead skin, thus providing blind or visually impaired about objects surrounding them [11] and helping to orient and move outside.

Similar (optical scanning) principle is implemented in “Magic Finger” device [12], which can be used for reading information on various surfaces. “Magic Finger”, equipped with a pair of optical sensors, is able to recognize what it touches (32 different surface textures with 98 percent accuracy), and with this information turn various surfaces into interfaces for devices or a way of passing information. However, this device does not make any tactile influence on the user finger.

“wUbi-Pen” device (haptic stylus) [13] also reads graphic and symbolic information from computer screen or mobile device in optical way (by camera) but differently than “Magic Finger” transfers it to user in tactile way ( $3 \times 3$  pins block, 3 mm between pins). The device may “inform” its user by vibration, impact or sound, it allows even simple contours to be drawn, however is unable to recognize colour of the object displayed, its size, determined by the way of handling it, which seems to be one more quite important disadvantage.

“Tesla Touch” [14] – technology allowing delivering users of devices with touch interfaces with tactile feedback thus ensuring some dynamic tactile feedback. It is based on the electrovibration principle: it does not use any moving parts and provides a wide range of tactile feedback sensations to fingers moving across a touch surface by variable friction force. The main problem of this system is that it is necessary to use high voltages to control the friction force caused by electrovibration.

According to the destination (usage with touch-based interfaces the popularity of which has been rapidly growing) the piezoelectric thimble under development is close to the two last devices mentioned. It transforms information shown on the screen into classical tactile excitation of the finger skin like “wUbi-Pen”, but is more compact and in addition is designed with intention to inform its user about the color of the objects displayed on the interface either, the same as “Tesla Touch”. But due to the principle of generation of the tactile signal piezoelectric thimble seems to be cheaper and less energy consuming than the latter (at least for the moment), which herewith increases mobility of its user, and more effective (informative), because excites finger skin not only during movement of the finger on the surface of the screen of mobile device.

Perhaps the main problem faced by developers of various tactile devices is evaluation of their tactile efficiency. That is why most frequently exact information about the regimes of skin excitation is not provided when describing such devices, excluding general principles, for example, arrangement of the static excitation points defined yet by Braille and if to speak about devices described above – “wUbi-Pen”.

One of the ways of obtaining the necessary data is to investigate the stress–strain state of the human (or animal) skin by means of computational methods. There are a lot of skin computational models developed by different authors differing in description of skin sort (finger, arm, sole, leg, etc.) geometry (shape, number and thickness of layers [15]), description of material properties (from isotropic linear elastic to viscoelastic, etc.), type of problem (plane [16]–[19] or spatial, 3D, [20], [21] normal ant tangential, single and two point indentation [22] static or dynamic loading [23], and so on.

In the case under discussion to have ability to check the influence of a combination of several excitation points a 3D solid model was used (if there was only one needle far simpler plane model would be enough). A quite important feature of the model used in this research is the presence of the thinnest external layer of the skin – stratum corneum, whose Young’s modulus in the case of the finger skin is significantly higher than for most of the remaining skin of human body. Materials were treated as linearly elastic because of the relatively small excitation signal level and also having the aim to reduce time of computations of this study, treated by the authors as pilot one. One more simplification – the direct harmonic excitation of the skin instead of modeling

contact interaction between moving pin tip and skin surface, because in such a case transient (or time history) solution should be performed, which would be extremely time consuming. There again, not hard kinematic, but namely force excitation was used, which noticeably reduces the severity of such simplification. Excitation frequency range is extended intentionally having in mind the possibility to affect skin by piezoelectric thimble pins glued to the skin surface (presuming that this untypical case of high frequency kinematic loading may lead to interesting outcome).

To have more precise and adequate info about the behavior and the sensitivity of the fingertip skin excited by pins of piezoelectric thimble the computational model free of facilitations mentioned above is currently under development by the authors.

## 5. Conclusions

Summarizing the results of harmonic response analysis of the 3D finger–needle contact zone, the following conclusions can be made:

- The magnitude and distribution of shear and normal elastic strain in the skin under harmonic excitation vary significantly, depending on frequency of excitation (shear strain – from  $\sim 0.5\%$  to  $2.5\%$ , normal – from  $\sim 15\%$  to near  $1\%$ );
- In most cases maximal strains are obtained with lower frequencies of excitation (up to 4000 Hz);
- Numbers of maximal and minimal strain zones depend on the number of excitation points on the human finger skin;
- Maximal and minimal shear strain zones are located in the bottom plane of the human skin dermis layer;
- Location of zones with maximal and minimal normal strain vary more significantly with frequency, moving from bottom surface of dermis to its middle or even top surface.

Research results show that configuration of excitation needles (number of the points and oscillating phase) and their frequencies can influence the information transferring to the blind human finger. This information will be utilised when developing piezoelectric actuators with 2 and 3 oscillating needles.

## Acknowledgement

This work has been supported by Research Council of Lithuania, Project No. MIP-042/2011.

## References

- [1] AZUBALIS M., BANSEVICIUS R., *Computer mouse type input –output device*, State Patent of Lithuania, No. 5159 B, 2002.
- [2] AZUBALIS M., BANSEVICIUS R., TOLOCKA R. T., JURENAS V., *Research of the tangential movement of the tactile device*, Ultragarasas ISSN:1392-2114, Technologija, Kaunas, 2004, Vol. 3, No. 52, 33–37 (in Lithuanian).
- [3] GRIGAS V., TOLOCKA R.T., ŽILUKAS P., *Dynamic interaction of fingertip skin and pin of tactile device*, Journal of Sound and Vibration, London, Elsevier Science. ISSN 0022-460X. 2007, Vol. 308, Iss. 3–5, 447–457.
- [4] BANSEVICIUS R., DRAGAŠIUS E., MAŽEIKA D., JÜRĖNAS V., SKIEDRAITĖ I., ŽVIRONAS A., *R&D of the device for blind to conceive 2D graphical information*, Journal of Vibroengineering, 2012, Vol. 14, 1444–1449.
- [5] *Skin Rejuvenation with Ablative Laser.*: <http://www.mylooks.co.uk/treatments/ablative-laser/skin-rejuvenation>. Accessed 5 February 2014
- [6] GERLING G.J., THOMAS W., *The Effect of Fingertip Microstructures on Tactile Edge Perception*, Proceedings of the First Joint Eurohaptics Conference and Symposium on Haptic Interfaces for Virtual Environment and Teleoperator Systems, World Haptics 2005, First Joint, Conference Publications, 63–72.
- [7] MAENO T., KOBAYASHI K., YAMAZAKI N., *Relationship between the Structure of Human Finger Tissue and the Location of Tactile Receptors*, Bulletin of JSME International Journal, 1998, Vol. 41, No. 1, C, 94–100.
- [8] HU J., XIN D., WANG R., *Dependence of tactile sensation on deformations within soft tissues of fingertip*, ISSN 1 746-7233, England, UK World Journal of Modelling and Simulation, 2007, Vol. 3, No. 1, 73–78.
- [9] LEDERMAN S.J., *Skin and touch*, Queen’s University, <http://psycserver.psyc.queensu.ca/lederman/106.pdf>. Accessed 5 February 2014.
- [10] GOULD W.R., VIERCK C.J., LUCK M.M., *Cues supporting recognition of the orientation or direction of movement of tactile stimuli*, [in:] D.R. Kenshalo (ed.), *Sensory Functions of the Skin in Humans*, Plenum Press, New York 1979, 63–78.
- [11] KAJIMOTO H., KANNO Y., TACHI S., *Forehead Electro-tactile Display for Vision Substitution*, EuroHaptics, Paris, France, July 3–6, 2006, <http://citeseerx.ist.psu.edu/viewdoc/download?doi=10.1.1.79.6965&rep=rep1&type=pdf>, Accessed 14 March 2014.
- [12] SZONDY D., *Magic Finger turns any surface into a touch interface*, October, 2012, <http://www.gizmag.com/magic-finger-interface/24544/>, Accessed 14 March 2014.
- [13] KYUNG KI-UK. WUBI-PEN: Windows Graphical User Interface Interacting With Haptic Feedback Stylus. SIGGRAPG 2008, The 35th International Conference and Exhibition on Computer Graphics and Interactive Techniques. <http://www.siggraph.org/s2008/attendees/newtech/11.php>, Accessed 14 March 2014.
- [14] BAU O., POUPYREV I., ISRAR A., HARRISON Ch., *TeslaTouch: Electro-vibration for Touch Surfaces*, 23rd ACM UIST Symposium, USA, New York 2010. <http://www.chrisharrison.net/projects/teslatouch/teslatouchUIST2010.pdf>, Accessed 14 March 2014.
- [15] THALMANN N.M., KALRA P., LÉVÊQUE J. L., BAZIN R., BATISSE D., QUERLEUX B.A., *Computational Skin Model: Fold and Wrinkle Formation* IEEE Transactions on Information Technology in Biomedicine, Dec. 2002, Vol. 6, Iss. 4, 317–323.



- [16] RICKER S.L., ELLIS R.E., *2-D Finite-Element Models of Tactile Sensors*, Proceedings of the IEEE International Conference Robotics and Automation, 1993, Vol. 1, 941–947.
- [17] MAENO T., KAWAI T., KOBAYASHI K., *Analysis and Design of a Tactile Sensor Detecting Strain Distribution Inside an Elastic Finger*, Proceedings of the IEEE/RSJ Intl. Conference on Intelligent Robots and System, Victoria, B.C., Canada, October 1998, Vol. 3, 1658–1663.
- [18] MORI M., MAENO T., YAMADA Y., *Method for Displaying Partial Slip used for Virtual Grasp*, Proceedings of the IEEE/RSJ Intl. Conference on Intelligent Robots and Systems, Las Vegas, Nevada, October 2003, 3100–3105.
- [19] *An Investigation of the Mechanics of Tactile Sense Using Two-Dimensional Models of the Primate Fingertip*, M. A. Srinivasan, K. Dandekar, Journal of Biomechanical Engineering, 1996 Feb., 118(1), 48–55.
- [20] DANDEKAR K., RAJU B.I., SRINIVASAN M.A., *3-D Finite-Element Models of Human and Monkey Fingertips to Investigate the Mechanics of Tactile Sense*, Journal of Biomechanical Engineering, October 2003, Vol. 125, Issue 5, 682–691.
- [21] WU J.Z., WELCOME D.E., DONG R.G., *Three-dimensional finite element simulations of the mechanical response of the fingertip to static and dynamic compressions*, Computer Methods in Biomechanics and Biomedical Engineering, ISSN 1025-5842 print/ISSN 1476-8259 2006 Feb., 9(1), 55–63.
- [22] WU J.Z., DONG R.G., RAKHEJA S., SCHOPPER A.W., SMUTZ W.P., *A structural fingertip model for simulating of the biomechanics of tactile sensation*, Medical Engineering and Physics, 2004, 26, 165–175.
- [23] NISHIYAMA J., TSAI C.-H.D., QUIGLEY M., IMIN KAO, SHIBATA A., HIGASHIMORI M., KANEKO M., *An experimental study of biologically inspired artificial skin sensor under static loading and dynamic stimuli*, Proceedings of the IEEE International Conference Robotics and Automation, Shanghai, China, 2011, 1778–1783.