



***In vitro* cytotoxicity of biodegradable Zn-Mg surgical wires in tumor and healthy cells**

ANDRIJ MILENIN¹, KRZYSZTOF ŁUKOWICZ², KAROLINA TRUCHAN², ANNA MARIA OSYCZKA^{2*}

¹ AGH University of Science and Technology, Faculty of Metals Engineering and Industrial Computer Science, al. Mickiewicza 30, 30-059 Kraków, Poland.

² Jagiellonian University, Faculty of Biology, Institute of Zoology and Biomedical Research, Department of Cell Biology and Imaging, Gronostajowa 9, 30-387 Kraków, Poland.

In this work, we examined the *in vitro* cytotoxicity of new biodegradable surgical wires. The wires made of zinc with the addition of a small amount of magnesium (pure zinc, ZnMg 0.0026, ZnMg 0.0068, and ZnMg 0.08) have been investigated. The wires were produced using a technology based on extrusion and subsequent drawing. The resulting wires with a diameter of 0.8–1.0 mm are designed to be used in surgical operations related to bone joints. For cytotoxicity studies, we have selected human dental pulp stem cells (hDPSC) as the cell population representing normal osteoprogenitor cells. Considering that, after bone surgeries, the chance of osteosarcoma increases, we have compared the results obtained in hDPSC to those obtained with Saos-2 human osteosarcoma cell line. Cultured cells were exposed to the extracts obtained from the materials incubated in culture medium for 24 h with and without preincubation. Extracts of different ratios were examined. The results showed that the extracts obtained from wires made of ZnMg 0.0026 alloy exhibit high toxicity to Saos-2 osteosarcoma cells and low toxicity to hDPSC cells. This was in contrast to all reference materials, i.e., commercial surgical sutures made of steel and polymers, that did not display cytotoxicity toward osteosarcoma cells. Thus, the detected phenomenon for the ZnMg 0.0026 alloy can become the basis for creating biodegradable Zn-Mg surgical wires with antitumor activity.

Key words: surgical wires, ZnMg alloys, tumor, drawing, biodegradation, cytotoxicity

1. Introduction

The biodegradable metal surgical wires can serve as a substitute for steel sutures in the case of operations that require significant loads to tighten the wound such as bone surgeries. Three metals are currently considered as promising base materials for such threads: Mg, Fe, and Zn [18].

Magnesium has the highest recommended daily intake of 375 to 500 mg in humans [19], but magnesium alloys have too high corrosion rates and insufficient ductility for this application [14]. There is also a significant, up to 50% decrease in the strength of the wire made of magnesium alloy when tying a surgical knot [13]. Also, when magnesium corrodes,

hydrogen is released, which poses a risk of local cytotoxicity [5].

Iron has sufficient mechanical properties, but the biocompatibility of its biocorrosion products is low [17]. The disadvantage relies also in its ferromagnetic behavior and insufficient rate of biocorrosion [23].

Zinc has fairly good biocompatibility *in vivo*, but its strength for this type of application is insufficient [22]. As shown in [9], by alloying zinc with magnesium it is possible to eliminate this disadvantage. In addition to increasing the strength of the material to 350–400 MPa, work [9] provides data on its good biocompatibility *in vivo*. After a 12-week test period, no inflammatory response was observed in living tissue [9]. On the other hand, it was shown in [8] that biocompatibility *in vivo* depends on the magnesium

* Corresponding author: Anna M. Osyczka, Jagiellonian University, Faculty of Biology, Institute of Zoology and Biomedical Research, Department of Cell Biology and Imaging, ul. Gronostajowa 9, 30-387 Kraków, Poland. Phone: +4812 664-5342, e-mail: anna.osyczka@uj.edu.pl

Received: September 3rd, 2021

Accepted for publication: November 26th, 2021

content in zinc. Although magnesium itself has better biocompatibility than zinc, increasing the magnesium content in zinc worsens the biocompatibility of the Zn-Mg alloy *in vivo*. For this reason, alloys containing small magnesium additions (up to wt. of 0.1%) were studied in [8]. It was shown that in this case, sufficiently high strength properties could be achieved.

Many researchers note that zinc and zinc-based alloys display good biocompatibility *in vivo* [22]. At the same time, the results of the *in vitro* cytotoxicity tests following the ISO 10993-12: 2012 (E) standard appear to depend on the type of cells used and other factors [9]. It is believed that the reason for the high toxicity of zinc and its alloys to some types of cells is the excessive concentration of zinc ions. On the other hand, lower concentrations of zinc ions lead to low toxicity and good cell survival [10].

It is also known that zinc ions have a negative effect on cancer cells [4]. Also, a decrease in the zinc content in healthy cells is one of the signs of a precancerous condition [3]. Most of the published data refer to prostate cancer; however, in [4], it is concluded that a similar phenomenon can be manifested for other types of cells, which requires, however, additional evidence and research.

An additional practical problem is that with high toxicity to cancer cells it is necessary to achieve low toxicity to normal, healthy cells. Provided that this problem is solved, it could be possible to create threads with an anti-cancer effect. In principle, a similar idea was expressed, for example, in [1], for implants made of magnesium alloys. However, the question of selective cytotoxicity of alloys based on Zn and Mg has not been answered. With high toxicity to cancer cells, low toxicity to healthy cells is not guaranteed. Besides, the choice of types of healthy and cancer cells depends on the potential application of the developed implants.

Several researchers have shown in the experiments *in vitro* that zinc is more cytotoxic in cancer cells than in healthy cells [7], [21]. In [4], some hypotheses are given explaining this phenomenon. Without going into the essence of the hypotheses, we have sought to examine high-strength Zn-Mg surgical threads for potential anti-cancer activity.

It is important to note the complexity of such task, giving that the material of the thread interacts *in vivo* with several cell types. In this work, we limited ourselves to the study of two clinically relevant cell lines related to bone surgery, namely, human dental pulp stem cells (hDPSC) that display high osteogenic potential [2] and osteosarcoma cell line (Saos-2), the appearance of which can be triggered by bone injury or as a result of cancer recurrence and metastasis [20].

We chose the magnesium content in the Zn-Mg alloy as a factor potentially affecting the cytotoxicity of the material of the thread. Thus, the primary goal of this work was to develop a soluble surgical wire based on Zn-Mg alloys, displaying the maximum cytotoxicity to cancer cells and good biocompatibility with healthy osteoprogenitor cells. In addition, we have examined the effect of the extract ratio and the preincubation time on the cytotoxicity of the thread for both healthy and malignant cells.

2. Materials and methods

2.1. Materials

The original purpose of adding magnesium to zinc was to increase the strength of the wire material compared to pure zinc. At the same time, an increase in the magnesium content worsens the biocompatibility of Zn-Mg alloys [8]. We hypothesized that this change in biocompatibility does not apply equally to different cell types. If this is true, then by regulating the magnesium content in zinc, one can try to achieve high toxicity to cancer cells with low toxicity to healthy cells. Based on this hypothesis, threads were produced from 4 materials with an increasing magnesium content: commercial pure zinc, and alloys:

ZnMg0.0026 (0.0026 wt. % Mg; Sn < 0.0005; Al < 0.0005; Cd < 0.0005; Cu < 0.0005; Pb 0.0015; Fe < 0.0005; Zn – balance); ZnMg0.0068 (0.0068 wt. % Mg; Sn < 0.0005; Al < 0.0005; Cd < 0.0005; Cu < 0.0005; Pb 0.0019; Fe < 0.0005; Zn – balance); ZnMg0.08 (0.081 wt. % Mg; Sn < 0.0005; Al < 0.0005; Cd < 0.0005; Cu < 0.0005; Pb 0.0014; Fe < 0.0005; Zn – balance).

As a workpiece of commercial pure zinc, a wire with a diameter of 1.6 mm obtained by the Properzi method with standards DIN EN ISO 14919 and EN 1179 was used. Pure zinc was used as a reference material because its strength is insufficient for this class of filaments. Drawing pure zinc to diameters of 0.8–1 mm was carried out at room temperature.

Zinc–magnesium alloys were made by adding magnesium to molten zinc in an induction furnace. After that, the alloys were cast into ingots with a diameter of 100 mm. After casting, the ingots were cut into billets with a height of 160 mm. The control of the chemical composition was performed using the atomic absorption spectroscopy (AAS) method. The next step

was extruding the ingot through a die with 30 channels. The diameter of each channel was 1.8 mm. The extrusion temperature was 280 °C, the extrusion speed was 0.15 mm/s. Further, the material was drawn to diameters of 0.8–1 mm with the use of the installation shown in Fig. 1. This installation allows both hot drawing and cold drawing. Drawing to a diameter of 1.34 mm was carried out at a temperature of 250 °C to improve the workability of the material. In this case, a graphite-based lubricant was used. The further process of drawing to diameters of 0.8–1 mm was carried out at room temperature. In this case, a liquid soap-based lubricant was used. The elongation in each drawing pass was 10%.

The achieved ultimate strength of the wire with a diameter of 1 mm was Zn: 113.3 ± 8.4 MPa; ZnMg 0.0026: 251.5 ± 0.78 MPa; ZnMg 0.0068: 252.3 ± 0.93 MPa; ZnMg 0.08: 316.1 ± 3.13 MPa. The relative elongation A_{200} was Zn: $36.3 \pm 3.1\%$; ZnMg 0.0026: $3.67 \pm 0.65\%$; ZnMg 0.0068: $8.95 \pm 1.5\%$; ZnMg 0.08: $4.55 \pm 1.4\%$.

The measurements of the listed parameters were carried out on a Zwick250 machine with a triple repetition of experiments for each material. The tests were carried out at a strain rate of 0.005 s^{-1} . At a specimen length of 200 mm this corresponds to a stretching rate of 1 mm/s and it is close to the mechanical conditions upon the formation of a surgical knot. The ultimate strength values obtained for the ZnMg 0.0026 alloy exceeded the values obtained in [8] for a material with a similar chemical composition (ZnMg 0.002). There are couple explanations for this finding.

1. In the study [8], the strain rate was 0.001 s^{-1} , which is 5 times less than in the present study. Zinc alloys are strain rate sensitive due to the low melting point of zinc (692.5 K). Room temperature (293 K) for these alloys corresponds to a homologous temperature of 0.42, which is higher than the recrystallization temperature [12].
2. Even a small increase in the magnesium content enhances the hardening of alloys of the Zn-Mg system. An approval of this can be found in papers [8], [15], where, in particular, the strength of a wire made of Zn-Mg alloys with different magnesium content was investigated.
3. Mechanical properties also depend on the way the material is processed. Thus, in our experiments, the ZnMg0.0026 alloy, after extrusion, is characterized by an ultimate strength of 126.7 ± 4.0 MPa, and after the drawing scheme described above, this value increased almost twofold. This effect is known, and it is due to the formation of different

texture of deformation in different metal forming processes. Similar effects were described for example by [16] (effect of extrusion on properties) or [11] (effect of rolling). As applied to the wire drawing process of Zn-Mg alloys, this issue was investigated in [15], where the effect of material texture on mechanical properties and biocorrosion was confirmed.

A very important indicator of usability and ductility of surgical wire is the number of kinks to failure. The number of bending to failure of the wire with a diameter of 1 mm according to ISO 7801 was: ZnMg 0.0026: 59.67 ± 10.6 ; ZnMg 0.0068: 46.17 ± 5.37 ; ZnMg 0.08: 47.57 ± 5.06 .

After the hot drawing, the wire was cleaned in an ultrasonic bath with soapy water for 15 min. After the last two passes, cleaning took place in 70% alcohol in an ultrasonic bath for 15 minutes.

Steel surgical 0.8 mm wire (negative test), copper 1.0 mm wire (positive test), commercial soluble poly and monofilament threads Monosyn[®] 2/0, POLYDIOXANONE 2/0, USP-1 were used as reference materials.

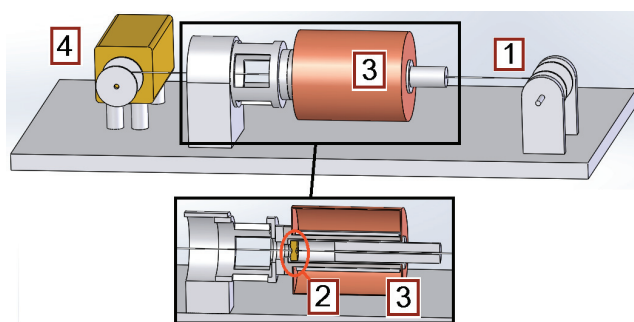

Fig. 1. Installation for hot and cold drawing processes: 1 – wire; 2 – drawing die; 3 – heating device; 4 – engine; drawing direction – from right to left

2.2. Biocorrosion

The cytotoxicity of zinc-based alloys is associated with a high concentration of zinc ions in the extract during biocorrosion [10]. On the other hand, biocorrosion forms a protective layer of corrosion products, which reduces the corrosion rate, concentration of zinc ions [6] and improves cytotoxicity indicators. This issue has been well studied for zinc-based alloys, including Zn-Mg alloys. However, there are no such studies in the literature for the materials used in this work. The aim of our study of biocorrosion was to assess the change in the rate of corrosion over time, which, in turn, may allow us to use the preliminary incubation

of samples to reduce the cytotoxicity of the developed threads.

The biocorrosion research technique described by us [14] was used. A mixture of bovine serum supplied by Biowest (catalog no. S0250) and heated to 37 °C was used as a corrosion medium. After each test period, the samples were removed from the corrosive medium and the change in the samples weight was determined using a laboratory analytical balance (accuracy of 0.00001 g). One of the three methods proposed in the ASTM_G1_03_E standard (Standard Practice for Preparing, Cleaning, and Evaluating Corrosion Test Specimens) was selected for cleaning conditions of corrosion products. In the tests applied in this work, mechanical cleaning of the surface of the tested material was used. Immediately before the test and before each weighing, samples were thoroughly cleaned first with the distilled water and then ultrasonically in ethanol and finally dried out at room temperature according ASTM G1-03-E standard. By this way efforts were made to reproduce conditions similar to *in vivo* conditions as much as possible. The weighing was carried out after 3, 7, and 14 days of immersion in the corrosion medium. Each test was repeated 3 times for each alloy. Mono-filament wires with a diameter of 1 mm, a length of 36 mm, and an initial weight of 0.2 g each were used. The corrosion rate was calculated using the equation:

$$CR = 365 \frac{m_0 - m_{corr}}{\rho A \tau},$$

where m is the mass [g] of the sample [g] before (m_0) and after (m_{corr}) corrosion for given time (τ days). A is the surface [mm^2] of the sample exposed to the corrosion, determined at each stage of the corrosion test, and ρ is the alloy density (i.e., 7.14 g/cm^3 in this study).

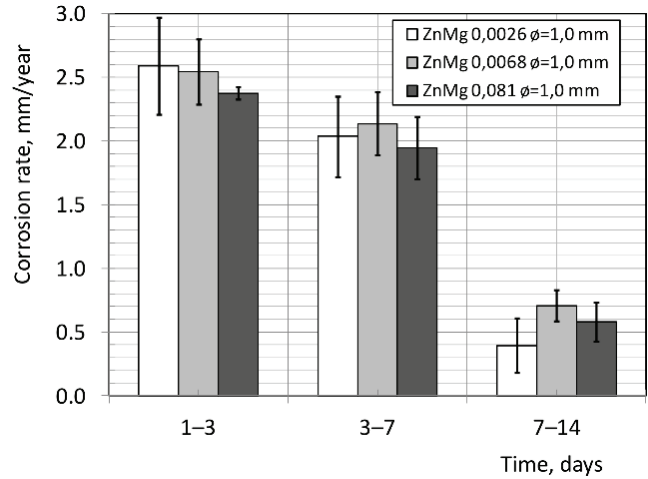

Fig. 2. Change of corrosion rate in time for three Zn-Mg alloys

The results are shown in Fig. 2. The calculations were carried out for adjacent time intervals; therefore, the obtained values represent the average corrosion rate at time intervals of 1–3 days, 3–7 days, and 7–14 days. A typical image of a corroded wire surface with uniformly distributed corrosion products is shown in Fig. 3.

Corrosion results confirmed the formation of a protective layer of corrosion products on the surface and a decrease in the corrosion rate over time.

Deepenings in the surface visible in Fig. 3a are the result of the original surface irregularity of the work-piece, partially smoothed out during the wire drawing process. Similar defects also exist for pure zinc [14]. As shown in [14], biocorrosion leads to their rapid disappearance.

2.3. Material sterilization

The investigated wires were cut into pieces of approx. 1-cm long. Ethanol sterilization was applied. SEM images of the representative Zn-Mg wire surface after

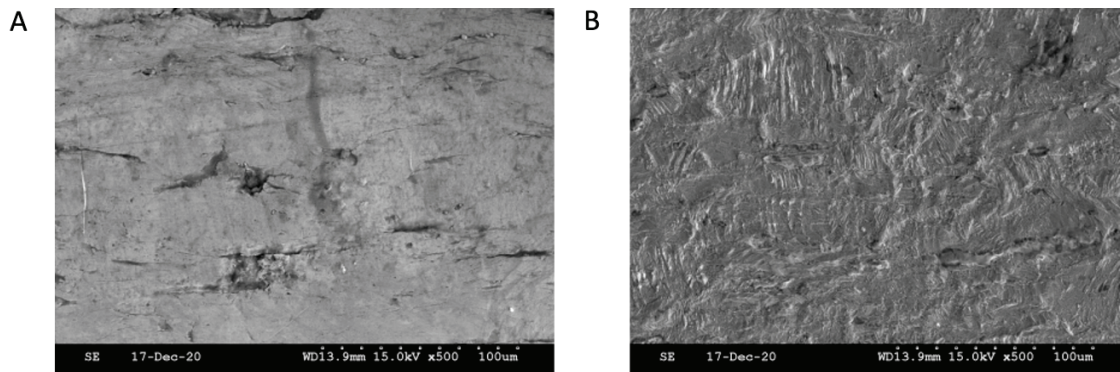

Fig. 3. SEM images of the surface of the wire made of ZnMg0.0026 alloy: A – after drawing; B – after 14 days biocorrosion (Hitachi S-3500N microscope)

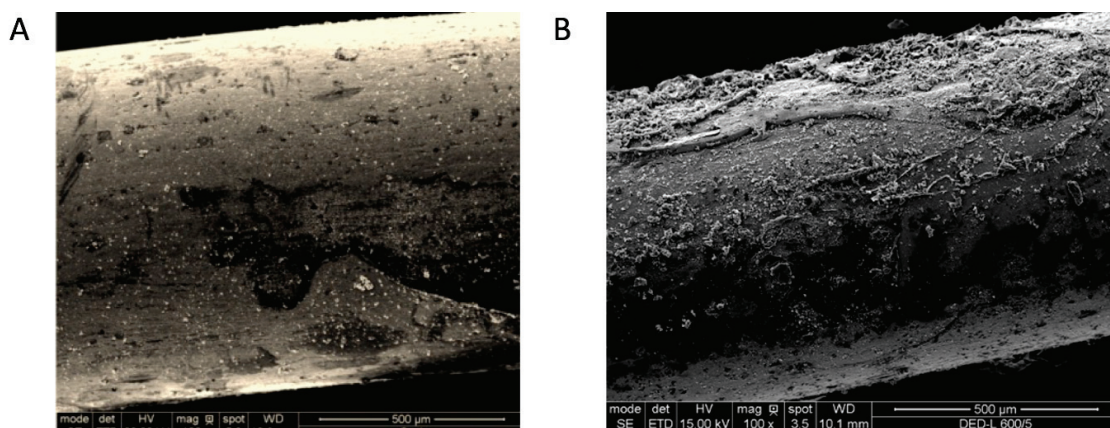

Fig. 4. SEM images of the wire made from ZnMg0.0026 alloy after sterilization (A) and after 24 h incubation in a culture medium (B) (obtained on a Hitachi S-3500N microscope)

ethanol sterilization and 24 h incubation in the incubation media (section 4.2) are shown in Fig. 4. As seen in the SEM image, ethanol sterilization did not significantly alter the surface. However, during the test, corrosion products were observed on the wire surface (Fig. 4b).

2.4. Preparation of extracts

To study the cytotoxicity of threads, an indirect method based on obtaining a material extract was

used. The ratio of surface area to extract volume following ISO 10993-12: 2012 (E) is often used to determine the extraction ratio. For a material with a diameter of about 1 mm, the required ratio is 3 cm²/ml. However, it is not a straightforward task to determine the surface area that contacts surgical threads with the extract. Both mono- and multi-filament threads can be made of the same material. Examples of such threads are shown in Fig. 5. The accurate determination of the surface area on contact with the extract would be possible only for a mono-filament thread (Figs. 5b, 5f). Moreover, when a mono-filament thread is tied into

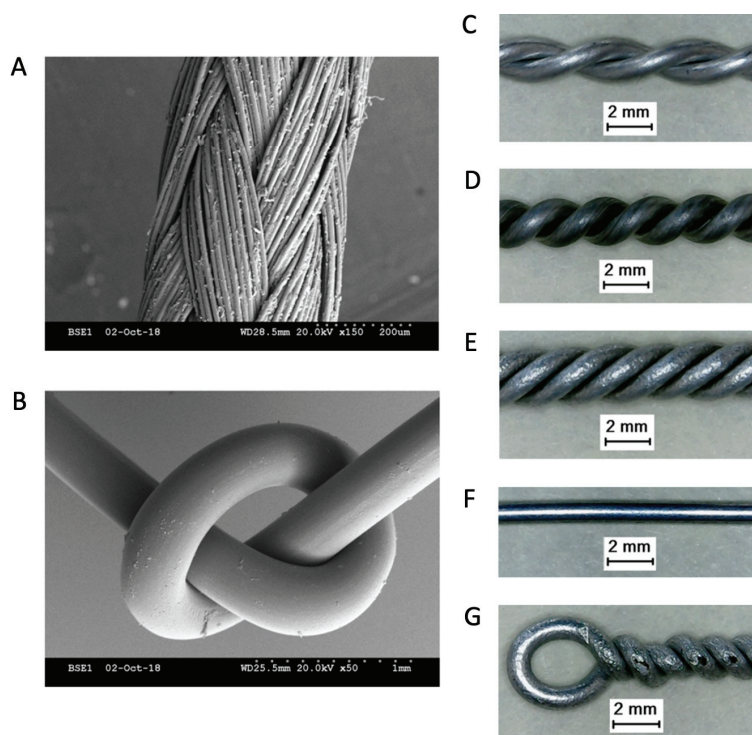

Fig. 5. Different types of surgical bio-degradable threads: A – PolysorbTM 3-0; B – MonosynR 2-0 (Hitachi S-3500N microscope); C, D – two-filament Zn-Mg threads; E – four-filament Zn-Mg thread; F – mono-filament Zn-Mg thread; G – mono-filament Zn-Mg surgical thread in a surgical knot (the light microscope)

a surgical knot, it takes on a complex shape and then it is difficult to determine the real area of the material surface that contacts the extract (Figs. 5b, 5g). Given that the surface area could not be determined due to the configuration of the sample, and because we wished to use a uniform approach to study all types of experimental threads, we used the base ratio of 0.2 g/ml, according to recommended ISO 10993-12:2012 (E) norm for “Irregularly shaped solid devices, non-absorbent moulded item” (Table 1 of ISO 10993-12: 2012 (E)). For those cases, where it was possible to determine the contact area, we additionally indicated the ratio of the contact area to the volume of the extract. In our experiments we used two-filament threads (Fig. 5d), for which the total surface area of the filaments could be calculated. This gave us an upper estimate for the surface-to-volume ratio of the extract. For all investigated Zn-Mg alloys weighing 0.2 g, it was 1.12 cm²/ml for a filament diameter of 1 mm and 1.4 cm²/ml for a filament diameter of 0.8 mm. Since part of the filament surface does not contact the extract, the above ratios are overestimated. Following ISO 10993-12:2012 (E), all tested threads were cut into pieces of approximately 10 mm length.

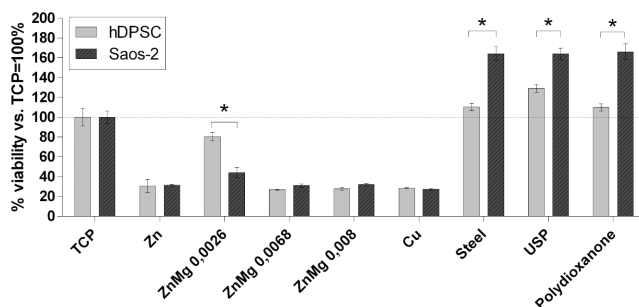

Fig. 6. Cells viability after 24 h exposure of cells to the extracts obtained after 72 h materials preincubation, extract ratio 0.2 g/ml, wires 1 mm.

* $p < 0.05$ within the group; please note that all studied extracts significantly affected cell viability vs. respective TCP controls

Thus, in this work, we used an extract ratio of 0.2 g/ml following ISO 10993-12: 2012 (E) or an extract ratio of 0.04 g/ml, which corresponded to 1.12 cm²/ml and 0.224 cm²/ml for filament with diameter 1 mm and 1.4 cm²/ml and 0.28 cm²/ml for filament with diameter 0.8 mm. After cutting and sterilizing the materials, they were soaked in a culture medium containing Minimum Essential Medium α (MEM α , Thermo Fisher Scientific) and 10% fetal bovine serum (FBS, Thermo Fisher Scientific) for either 24 h (group 1) or preincubated in the above-mentioned medium for 72 h, then washed in phosphate buffered saline (PBS) and incubated in a fresh medium for additional 24 h

(group 2). The extracts were collected from both groups.

2.5. Cell cultures

Both hDPSC and Saos-2 cells were seeded at the density of 2×10^4 cells/well in 24-well plates in the culture medium composed of MEM α , 10% FBS, and 1% antibiotics. After 24 h culture, the culture media were removed, cells were washed with PBS, and the extracts from studied materials divided to 3 culture wells/each extract type. The cells cultured in tissue culture plates (TCP) without the extracts were used as controls. Following the 24 h culture with the extracts, cells were washed 3 \times with PBS and next covered with 200 μ l MTS reagent (CellTiter96Aqueous One Solution Cell Proliferation Assay; Promega) diluted 10 \times in a phenol-free MEM α . For the colorimetric reaction development, cells were incubated in the culture incubator until obvious color change of the MTS solution from yellow to brownish. The solution was then transferred to 96-well plates and the absorbance at 492 nm was read using a plate reader. The results were expressed as % cell viability vs. respective TCP control.

2.6. Statistical analysis

All biological data were collected in triplicates and expressed as mean \pm SD. Statistical analyses were performed using one-way ANOVA and Bonferroni multiple comparisons test to calculate statistically significant differences at $p < 0.05$.

3. Results

We first used the extract ratio of 0.2 g material/ml incubation medium for the wires made of Zn-Mg alloys with a diameter of 1 mm. The cytocompatibility test was performed with the extracts obtained after 72-hour preincubation of the materials, as described in the previous section. The results showed that, within the experimental groups (i.e., Zn, ZnMg 0.08, ZnMg 0.0026 and ZnMg 0.0068), only the extract from the wire made of alloy ZnMg 0.0026 showed the satisfactory cell viability of normal hDPSC according to ISO standard (i.e., above 70%, Fig. 6). Notably, for this material only, the viability of hDPSC was significantly higher than that of Saos-2 osteosarcoma cell

line. Moreover, all used material controls, i.e., commercially available and clinically applicable steel, USP and polydioxanone significantly increased viability of both studied cell types vs. TCP control, but the effect was much stronger for the osteosarcoma cell line.

To explore further the biological properties of ZnMg 0.0026 alloy we used a wire made of ZnMg 0.0026 with a diameter of 0.8 mm (instead of 1 mm) and prepared material extracts with and without materials preincubation. As with initial experiment, these experiments were performed using an extract ratio of 0.2 g material/ml incubation medium. Cu and steel were used as material controls and TCP as cell culture control. As presented in Fig. 7, with and without material preincubation, the extracts obtained from ZnMg 0.0026 were more cytotoxic for osteosarcoma cells. Moreover, whereas steel extracts obtained without material preincubation showed some cytotoxicity to osteosarcoma cells, preincubation of steel provided extracts that led to a significant increase in viability of both hDPSC and the osteosarcoma cells and this effect was stronger for Saos-2 cells. The latter was consistent with the results presented in Fig. 6.

To examine the effect of the extract ratio on the cytotoxicity, the experiment was repeated with the extracts obtained without materials preincubation for 0.8 mm ZnMg 0.0026 wire, but with a reduced extract ratio, i.e., 0.04 g material/ml incubation medium. As presented in Fig. 8, reducing the extract ratio increases the difference in the viability of cancer and healthy cells for ZnMg 0.0026 in favor of healthy ones (compared to Fig. 7a). Interestingly, whereas with extract ratio 0.2 g material/ml incubation medium Cu extracts had obvious cytotoxic effect on both cell types, reducing the Cu extract ratio to 0.04 g material/ml incubation medium enabled normal hDPSC cells to survive at the level closed to required ISO norm. Also, compared to TCP control, extracts obtained from steel did not affect the growth/survival of both cell types, whereas Monosyn[®] slightly decreased viability

of Saos-2 cells. For the Monosyn[®], there was significant difference in the growth of normal vs. cancer cells. Most importantly, the extracts from ZnMg 0.0026 alloys were not cytotoxic for normal hDPSC cells, but highly toxic for osteosarcoma cells.

4. Discussion

Our results indicate a relationship between the magnesium content in Zn-Mg alloys and the cytotoxicity of such materials for normal human DPSC cells (Fig. 6). These results agree with the *in vivo* studies presented in [10], where the increase of the magnesium content in the zinc led to a deterioration in the biocompatibility of wires in a rat model. This was explained by an increase in the number of Zn2Mg11 particles, which suppress corrosion, but worsen biocompatibility by higher presence of inflammatory cell infiltrates around the wires *in vivo*. Our results show decreasing cell viability with increasing magnesium content in alloys of the Zn-Mg system for both normal and cancer cells, confirming further that too high magnesium content in the wires may be cytotoxic.

In general, though, magnesium is considered more biocompatible than zinc [18] and thus this study, along with previous reports of others, should be considered when designing Zn-Mg alloys for clinical purposes, to avoid potential chronic inflammatory reaction and local tissue cytotoxicity. This study enabled us to choose the magnesium content in zinc that compromises between mechanical and biological properties of the materials which may be eventually used for the manufacture of a new generation of bio-soluble surgical wires.

In addition, our study showed that the surgical wires made of the ZnMg 0.0026 alloy demonstrate low toxicity for normal cells (i.e., human DPSC) and high for cancer cells (i.e., Saos-2). Such effect was independent of material extract ratio used in this study (Figs. 7 and 8). Moreover, this effect was more profound with the lower extract ratio (Fig. 8). This suggests that the wires dissolution products may have different effects on normal and cancer cells survival rate. The latter may be especially important in the clinical surgeries associated with the tumor resection. The use of such wires could potentially inhibit the growth of any remaining cancer cells without affecting much normal cells rebuilding the tissue.

Currently used surgical wires made of steel or polymeric threads were used in this study as control materials and they all showed the tendency to increase

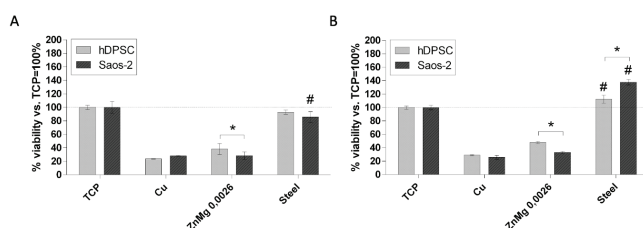

Fig. 7. Cells viability after 24 h exposure of cells to the extracts obtained without material preincubation (a) and with 72 h material preincubation (b), extract ratio 0.2 g material/ml incubation medium, wires 0.8 mm. * $p < 0.05$ within the group; # marks the significant difference in viability of cells exposed to steel samples vs. cells cultured on TCP

the survival of cancer cells (Fig. 6). Thus, the materials currently used in clinics may not inhibit the growth of cancer cells and, in some cases, they may facilitate cancer cell proliferation (Fig. 6). In contrast, experimental surgical wires made of ZnMg 0.0026 alloy seem to display cancer-preventive properties.

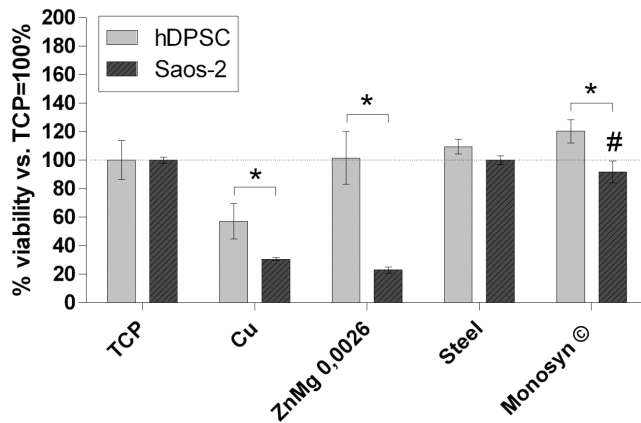

Fig. 8. Cells viability after 24 h exposure of cells to the extracts obtained without material preincubation; extract ratio 0.04 g material/ml incubation medium; wires 0.8 mm. * $p < 0.05$ within the group; # marks the significant difference in viability of cells exposed to Monosyn® samples vs. cells cultured on TCP

The anticancer effects can be assessed by the ratio of the cell viability of normal to cancer cells. In this study, for the ZnMg0.0026 alloys, this parameter varies in the range of 1.40–4.40, while for stainless steel it is 0.67–1.08. The calculation is based on the data presented in Figs. 6–8. Values less than 1.0 mean that cancer cells are more likely to survive than healthy cells. Such parallel evaluation of experimental materials in selected normal vs. cancer cell lines may set a new standard to distinguish materials that may display anticancer properties.

Dissecting the mechanism by which these and potentially other materials display anticancer properties is a separate issue that is not a subject of this work, but certainly it is going to be continued by us and others. Nevertheless, we have already found that the rate of biocorrosion of the studied ZnMg alloys is somewhat different, which may be associated with the observed biological effects.

The clinical application of the present findings are important, since osteosarcoma often appears at the sites of bone fractures [19], and surgical wires are intended to connect the bone not only after the mechanical fracture but also upon bone wound created due to resection of tumors. Thus, it is plausible to expect that the results obtained in this work prompt the materials engineers to create surgical wires being selectively toxic to cancer cells without

affecting normal cells growth and bone tissue regeneration.

5. Conclusions

We have analyzed the cytocompatibility of the Zn alloys in cultures of human osteosarcoma cell line Saos-2 and normal human dental pulp stem cells (hDPSC). The effects of magnesium content in Zn alloys and the extract ratio was examined. We have shown that Mg content of 0.0026 wt. % in the Zn-based wire provides extracts that are toxic to cancer cells and non-toxic to healthy cells. Thus, the developed threads may display an additional function, i.e., zinc delivery for anti-tumor activity. Our studies also showed that 72 h material preincubation before extract preparation does not change the results for the material ZnMg 0.0026. However, for all other reference materials, materials preincubation results in the extracts stimulating cancer cell viability. Decreasing the extract ratio improves the cytocompatibility of studied materials with healthy cells, but for ZnMg 0.0026 alloys, the opposite effects on healthy and cancer cells become most apparent. We believe the ZnMg 0.0026 alloys may prove useful in several anti-cancer therapies, but further studies are needed to examine the biological mechanism of their action as well as their specific clinical applications.

Acknowledgements

The research was supported in part by Ministry of Science and High Education of Poland, (Project No. 16.16.110.663, A.M.) and Polish National Science Center (Grant no. UMO-2016/21/B/NZ5/00217, A.M.O.).

References

- [1] ANISIMOVA N., KISELEVSKIY M., MARTYNYENKO N., STRAUMAL B., WILLUMEIT RÖMER R., DOBATKIN S., ESTRIN Y., *Cytotoxicity of Biodegradable Magnesium Alloy WE43 to Tumor Cells in Vitro: Bioresorbable Implants with Antitumor Activity?*, J. Biomed. Mater. Res. Part B Appl. Biomater., 2020, 108, DOI: 10.1002/jbm.b.34375.
- [2] CHING H., LUDDIN N., RAHMAN I., PONNURAJ K., *Expression of Odontogenic and Osteogenic Markers in DPSCs and SHED: A Review*, Curr. Stem Cell Res. Ther., 2016, 12, DOI: 10.2174/1574888X11666160815095733.
- [3] CORTESI M., FRIDMAN E., VOLKOV A., SHILSTEIN S.S., CHECHIK R., BRESKIN A., VARTSKY D., KLEINMAN N., KOGAN G., MORIEL E. et al., *Clinical Assessment of the Cancer Diagnostic Value of Prostatic Zinc: A Comprehensive Needle-Biopsy Study*, Prostate, 2008, 68, DOI: 10.1002/pros.20766.

- [4] COSTELLO L.C., FRANKLIN R.B., *Cytotoxic/Tumor Suppressor Role of Zinc for the Treatment of Cancer: An Enigma and an Opportunity*, *Expert Rev. Anticancer Ther.*, 2012, 12, DOI: 10.1586/era.11.190.
- [5] FISCHER J., PRÖFROCK D., HORT N., WILLUMEIT R., FEYERABEND F., *Improved Cytotoxicity Testing of Magnesium Materials*, *Mater. Sci. Eng. B*, 2011, 176, DOI: 10.1016/j.mseb.2011.04.008.
- [6] JABLONSKÁ E., VOJTĚCH D., FOUŠOVÁ M., KUBÁSEK J., LIPOV J., FOJT J., RUML T., *Influence of Surface Pre-Treatment on the Cytocompatibility of a Novel Biodegradable ZnMg Alloy*, *Mater. Sci. Eng. C*, 2016, 68, DOI: 10.1016/j.msec.2016.05.114.
- [7] JAYARAMAN A.K., JAYARAMAN S., *Increased Level of Exogenous Zinc Induces Cytotoxicity and Up-Regulates the Expression of the ZnT-1 Zinc Transporter Gene in Pancreatic Cancer Cells*, *J. Nutr. Biochem.*, 2011, 22, DOI: 10.1016/j.jnutbio.2009.12.001.
- [8] JIN H., ZHAO S., GUILLORY R., BOWEN P.K., YIN Z., GRIEBEL A., SCHAFFER J., EARLEY E.J., GOLDMAN J., DRELICH J.W., *Novel High-Strength, Low-Alloys Zn-Mg (< 0.1 Wt% Mg) and Their Arterial Biodegradation*, *Mater. Sci. Eng. C*, 2018, 84, DOI: 10.1016/j.msec.2017.11.021.
- [9] KUBÁSEK J., DVORSKÝ D., ŠEDÝ J., MSALLAMOVÁ S., LEVOROVÁ J., FOLTÁN R., VOJTĚCH D., *The Fundamental Comparison of Zn-2Mg and Mg-4Y-3RE Alloys as a Perspective Biodegradable Materials*, *Materials (Basel)*, 2019, 12, DOI: 10.3390/ma12223745.
- [10] LI P., DAI J., SCHWEIZER E., RUPP F., HEISS A., RICHTER A., KLOTZ U.E., GEIS-GERSTORFER J., SCHEIDELER L., ALEXANDER D., *Response of Human Periosteal Cells to Degradation Products of Zinc and Its Alloy*, *Mater. Sci. Eng. C*, 2020, 108, DOI: 10.1016/j.msec.2019.110208.
- [11] LIU S., KENT D., DOAN N., DARGUSCH M., WANG G., *Effects of Deformation Twinning on the Mechanical Properties of Biodegradable Zn-Mg Alloys*, *Bioact. Mater.*, 2019, 4, DOI: 10.1016/j.bioactmat.2018.11.001.
- [12] LIU S., KENT D., ZHAN H., DOAN N., DARGUSCH M., WANG G., *Dynamic Recrystallization of Pure Zinc during High Strain-Rate Compression at Ambient Temperature*, *Mater. Sci. Eng. A*, 2020, 784, DOI: 10.1016/j.msea.2020.139325.
- [13] MILENIN A., KUSTRA P., WRÓBEL M., PAČKO M., BYRSKA-WÓJCIK D., *Comparison of the Stress Relaxation of Biodegradable Surgical Threads Made of Mg and Zn Alloys and Some Commercial Synthetic Materials*, *Arch. Metall. Mater.*, 2019, 64, 1139–1143, DOI: <http://doi.org/10.24425/amm.2019.129506>.
- [14] MILENIN A., KUSTRA P., BYRSKA-WÓJCIK D., WRÓBEL M., PAČKO M., SULEJ-CHOJNACKA J., MATUSZYŃSKA S., PŁONKA B., *The Effect of in Vitro Corrosion on the Mechanical Properties of Metallic High Strength Biodegradable Surgical Threads*, *Arch. Civ. Mech. Eng.*, 2020, 20, DOI: 10.1007/s43452-020-00062-w.
- [15] MILENIN A., WRÓBEL M., KUSTRA P., PAČKO M., BYRSKA-WÓJCIK D., SULEJ-CHOJNACKA J., PŁONKA B., *Mechanical properties, crystallographic texture, and in vitro biocorrosion of low-alloyed Zn-Mg, produced by hot and cold drawing for biodegradable surgical wires*, *Archives of Civil and Mechanical Engineering*, 2021, 21, 163, DOI: 10.1007/s43452-021-00311-6.
- [16] PACHLA W., PRZYBYSZ S., JARZĘBSKA A., BIEDA M., SZTIWERTNIA K., KULCZYK M., SKIBA J., *Structural and Mechanical Aspects of Hypoeutectic Zn-Mg Binary Alloys for Biodegradable Vascular Stent Applications*, *Bioact. Mater.*, 2021, 6, DOI: 10.1016/j.bioactmat.2020.07.004.
- [17] SCHÜMANN K., ETTLE T., SZEGNER B., ELSENHANS B., SOLOMONS N.W., *On Risks and Benefits of Iron Supplementation Recommendations for Iron Intake Revisited*, *J. Trace Elem. Med. Biol.*, 2007, 21, DOI: 10.1016/j.jtemb.2007.06.002.
- [18] SEITZ J.-M., DURISIN M., GOLDMAN J., DRELICH J.W., *Recent Advances in Biodegradable Metals for Medical Sutures: A Critical Review*, *Adv. Healthc. Mater.*, 2015, 4, DOI: 10.1002/adhm.201500189.
- [19] SEITZ J.-M., EIFLER R., BACH F.-W., MAIER H.J., *Magnesium Degradation Products: Effects on Tissue and Human Metabolism*, *J. Biomed. Mater. Res. Part A*, 2014, 102, DOI: 10.1002/jbm.a.35023.
- [20] SERRA M., HATTINGER C.M., *The Pharmacogenomics of Osteosarcoma*, *Pharmacogenomics J.*, 2017, 17, DOI: 10.1038/tpj.2016.45.
- [21] SLIWINSKI T., CZECHOWSKA A., KOŁODZIEJCZAK M., JAJTE J., WISNIEWSKA-JAROSINSKA M., BŁASIAK J., *Zinc Salts Differentially Modulate DNA Damage in Normal and Cancer Cells*, *Cell Biol. Int.*, 2009, 33, DOI: 10.1016/j.cellbi.2009.02.004.
- [22] VENEZUELA J.J.D., JOHNSTON S., DARGUSCH M.S., *The Prospects for Biodegradable Zinc in Wound Closure Applications*, *Adv. Healthc. Mater.*, 2019, 8, DOI: 10.1002/adhm.201900408.
- [23] WEGENER B., SIEVERS B., UTZSCHNEIDER S., MÜLLER P., JANSSON V., RÖBLER S., NIES B., STEPHANI G., KIEBACK B., QUADBECK P., *Microstructure, Cytotoxicity and Corrosion of Powder-Metallurgical Iron Alloys for Biodegradable Bone Replacement Materials*, *Mater. Sci. Eng. B*, 2011, 176, DOI: 10.1016/j.mseb.2011.04.017.