

# **Tribological characteristics of enamel–dental material contacts investigated *in vitro***

SYLWIA WOJDA, BOGUSŁAWA SZOKA, EUGENIUSZ SAJEWICZ\*

Faculty of Mechanical Engineering, Białystok University of Technology, Białystok, Poland.

**Purpose:** The aim of this study was to investigate wear and friction behaviour of tooth enamel against selected dental restorative materials. **Methods:** The experimental material was obtained under simulated mastication, during which human tooth enamel was subjected to friction and wear in contact with composite dental materials: Estelite Sigma and FulFil Extra. **Results:** The results have shown that the enamel's resistance to tribological wear is significantly higher than the resistance of the dental materials tested. The microscopic observations of the sample surfaces subsequent to the tribological research as well as the analysis of the chemical composition of the surface layer confirm the existence of diverse tribological wear mechanisms dependent on the type of dental materials used. **Conclusions:** Composite materials such as Estelite Sigma and FulFil Extra are characterized by greater resistance to wear and are less destructive to enamel than the material investigated by the authors earlier. It has also been stated that the spherical shape of the filler particles (Estelite Sigma) has a beneficial effect in reducing enamel wear.

*Key words:* tooth enamel, dental material, wear, friction

## **1. Introduction**

Numerous studies on preventive dentistry materials conducted by various research centers have led to developments of yet higher performance products. At the same time, it should be noted that in spite of considerable progress in this regard, existing materials used for permanent dental fillings still yield, in many ways, to the hard tissues of the tooth. A significant “deficit” of natural properties is particularly observed with regard to tribological characteristics. Crucial in this respect is the assumed requirement that the materials developed should have resistance to tribological wear similar to that possessed by the enamel and at the same time exert little destructive effect on the tissues of the opposing teeth. In other words, the intensity of wear of the tooth tissue in contact with the tooth restorative material should be comparable to that existing in natural tissue contact.

Among the materials currently used to restore the loss of hard dental tissues the best tribological characteristics are manifested by composite materials [1], [19]. This is due to enormous possibilities of the composites to modify not only their chemical composition but also their structure so that they can be shaped in such a way as to reduce not only their wear but also the value of the friction coefficient. For nearly 40 years composites have been effectively replacing amalgam fillings that until now were (and sometimes still are) the right solution [2], [12]. In order to obtain desirable tribological parameters, appropriate types of fillers are used. Fillers differ in size, quantity and shape of the particles, which has a significant impact on the structure and properties of the composite [7], [18]. As reported in the literature, smaller volume ratio of particles of the filler fraction (20–50%) in the particle size range of 0.04–0.1 microns results in the deterioration of physicochemical and mechanical parameters of the material [3] (e.g., this leads to an

---

\* Corresponding author: Eugeniusz Sajewicz, Faculty of Mechanical Engineering, Białystok University of Technology, ul. Wiejska 45a, 15-351 Białystok, Poland. Tel: 48 85 746 92 52, e-mail: e.sajewicz@pb.edu.pl

Received: April 15th, 2014

Accepted for publication: June 16th, 2014

increase in the value of polymer shrinkage and of the thermal expansion coefficient as well as a reduction in mechanical strength – all these defects, however, can be minimized by the use of some new restoration placement techniques [17]). If, however, we introduce about 64% of inorganic phase, i.e., of the filler, and diversify the particle size, we obtain hybrid materials characterized by the properties intermediate between macro- and micro-particle materials with superior qualities [3].

There are various methodological approaches to study tribological behaviour of dental materials. However, experiments using enamel are, without doubt, the most appropriate methodologically as they make it possible to recreate natural conditions. At the same time, such tests are relatively rare, due to some difficulties in their implementation. Taking the above into account, the authors, by creating their own original research methodology, evaluated the interaction of enamel and two newly introduced to the market composite dental materials under sliding friction.

## 2. Materials and methods

The paper presents an analysis of the tribological characteristics of enamel and two composite materials intended for permanent dental fillings: Estelite Sigma (Tokuyama Dental, Japan – ES) – light-cured composite containing fillers in the form of spherical particles of submicron size (0.2–5  $\mu\text{m}$ ) and FulFil Extra ((DENTSPLY International Inc., USA – FFE) – micro-hybrid, light-cured composite with filler of the particle size varying from 0.04 to 5  $\mu\text{m}$ ). To carry out the experiment a modified pin-on-disc tribometer was used. Designed and manufactured at the Faculty of Mechanical Engineering of the Białystok University of Technology, the tribometer made it possible to subject the samples to both half-sine cyclic load tests and also reversing movements of the countersample. A detailed description of the device is available in another work of the authors [13]. Figure 1 shows a schematic diagram of the sample and countersample movements and also a photograph of the test unit. In the tests 20 individual

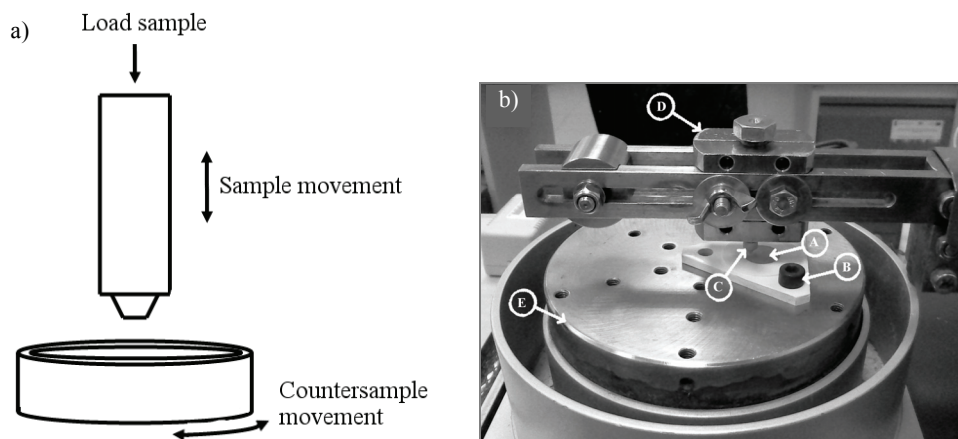

Fig. 1. (a) Sample and countersample movements; (b) photograph of friction testing unit: A – countersample (composite tested), C – sample, D – sample mounting mechanism, E – turntable

Table 1. Data relating to the test conditions

|                 |                              |  |                          |
|-----------------|------------------------------|--|--------------------------|
| Enamel samples  | Shape                        | Truncated cone                                       |                          |
|                 | Quantity                     | 40   |                          |
|                 | Shape                        | Disc   |                          |
|                 | Material                     | Light-cured composites: Estelite Sigma, FulFil Extra |                          |
| Test parameters | Load                         | Type   | Half sine                |
|                 |                              | Pressure units                                       | 6–60 MPa (average value) |
|                 | Countersample movement       | Reciprocating  |                          |
|                 | Single testing time          | 3 hours  |                          |
|                 | Frequency of sample movement | 1.58–1.62 Hz   |                          |
|                 | Wear track length            | Approx. 2.5 mm                                       |                          |
| Environment     | Temperature                  | Ambient (20–22 °C)                                   |                          |
|                 | Type                         | Artificial saliva                                    |                          |

measurements for each of the composites were performed changing every time the average load value. Table 1 gives a data summary of the test conditions.

The samples were prepared from molars and premolars obtained as a result of extractions carried out for orthodontic reasons. Prior to sample preparation the testing material, e.g., the teeth were kept in Hank's solution to protect the tooth enamel against excessive dehydration and maintain its hardness at an appropriate level [6]. The samples were made of enamel embedded into a cylindrical aluminium holder, while the countersamples were made of dental materials deposited in layers using special frames and cured with Blue Cap 1000 LED Curing Light (Dentazon) (Fig. 2). The tribological tests were held in artificial saliva prepared according to Fusayama's formula with Holland's modification [5]. The composition of the artificial saliva is shown in Table 2.

The tribological studies allowed us to collect the following relevant information on the behaviour of the friction pair enamel–dental material.

- volumetric wear of composite countersamples and enamel samples were determined,
- friction work for each measurement using a graphics program *Grapher* was calculated,
- the kinetics of changes of the friction coefficient was determined.

The wear track length was measured using a BX51 optical microscope. In order to obtain an actual range of the sample movement, the sample's diameter was subtracted from the measured length of the wear track. Eventually, the sliding distance calculated for a single

cycle was 2.5 mm. As for a single test, 18000 cycles were performed; the total sliding distance was approximately 45 m.

A total of 18000 cycles of bidirectional antagonist movements with a frequency of 1.58–1.62 Hz were accomplished. This range of frequency is adequate for the natural process of chewing and was also adopted in experimental studies by Heintze [7]. The mean of the sliding speed was 8 mm/s.

The tribological tests were supplemented with an additional analysis of the surface layer formed in the friction process, including: visual observations using a scanning electron microscope – Hitachi S-300N, observations using an optical microscope – Olympus BX51, and also a qualitative and quantitative analysis with EDS X-ray microprobe.

## 3. Results

### 3.1. Coefficient of friction

Figure 3 shows exemplary changes of friction coefficient corresponding to a single load cycle and illustrates the nature of the changes in the rate during the whole test conducted for the pairs enamel–ES and enamel–FFE. The value of the friction coefficient in the course of the investigation is a subject to change showing a slight downward trend similar to both of the composites.

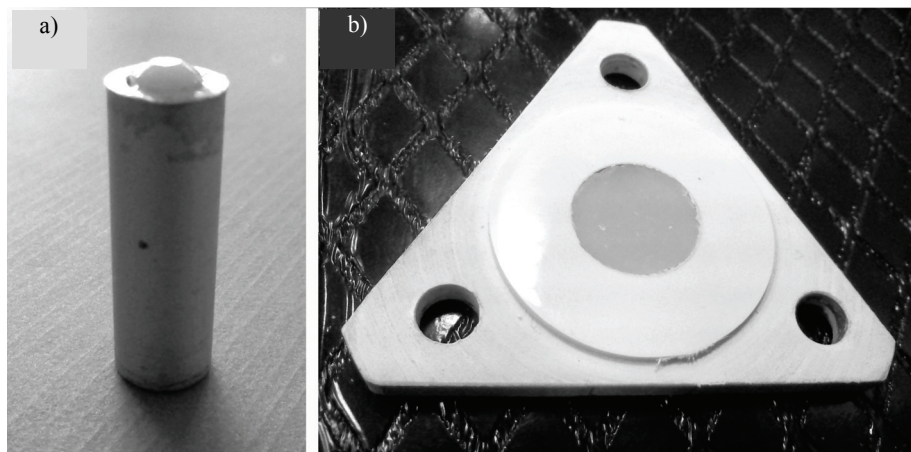

Fig. 2. (a) Sample view, (b) countersample view

Table 2. Composition of Fusayama's artificial saliva with Holland's modification [5]

| Reagent    | KCl | NaCl | CaCl <sub>2</sub> *2H <sub>2</sub> O | NaH <sub>2</sub> PO <sub>4</sub> *2H <sub>2</sub> O | Na <sub>2</sub> S*9H <sub>2</sub> O | Carbamide |
|------------|-----|------|--------------------------------------|---|-------------------------------------|-----------|
| Amount [g] | 0.4 | 0.4  | 0.795                                | 0.78  | 0.005                               | 1         |

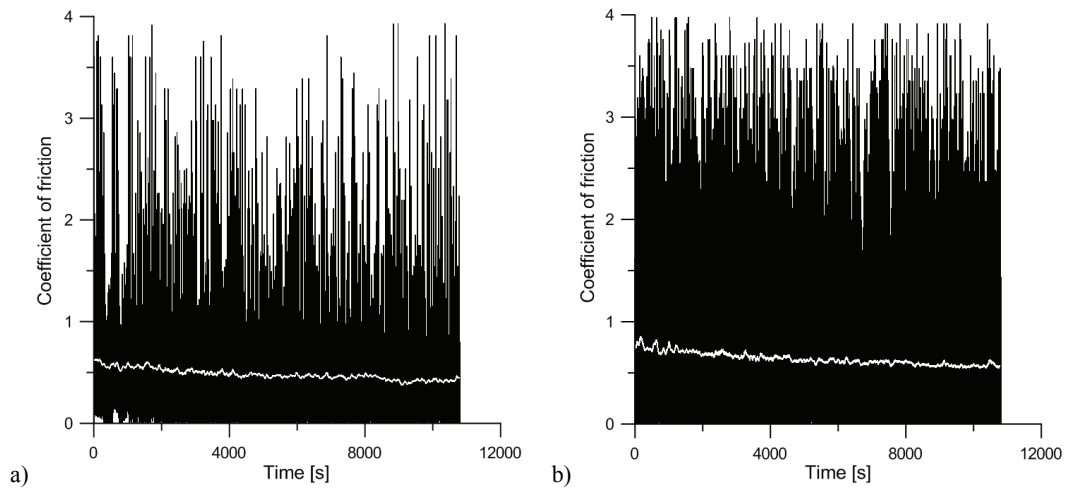

Fig. 3. Example graphs of coefficient of friction during the single test with running average:  
(a) enamel–FulFil Extra couple, (b) enamel–ES couple

### 3.2. Specific wear energy

To calculate friction work the graphics program *Grapher* was used. The program plotted charts of the friction force as a function of the sliding distance (Fig. 4). Next the value of friction work by measuring the area under the graph was calculated.

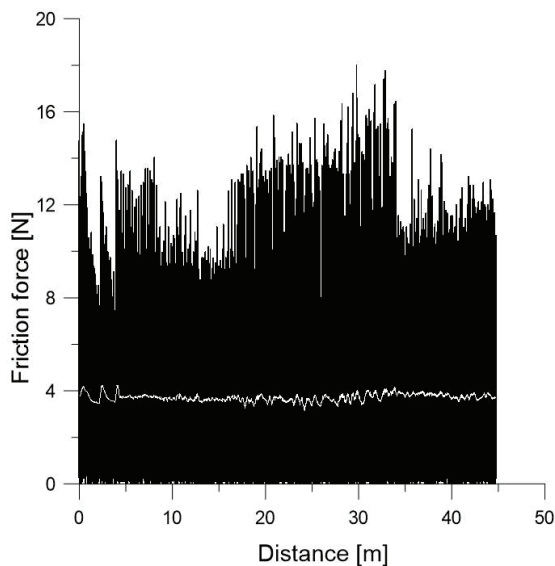

Fig. 4. An example graph of friction force as a function of the wear track with running average

In order to determine the specific wear energy, volumetric wear of the material investigated was measured. The volumetric loss of enamel samples made in the form of a truncated cone was calculated based on two consecutive measurements of the smaller diameter cone, before and after tribological testing. For this purpose the BX51 optical microscope was used, capable of measur-

ing with accuracy of 1  $\mu\text{m}$ . The volumetric wear was calculated from the formula that was used in earlier work of one of the authors [15] (Fig. 5)

$$Z_0 = \frac{\tan \alpha \pi}{24} (D_1^3 - D_0^3) [\text{mm}^3]$$

where

$Z_0$  – volumetric wear,

$\tan \alpha$  – tangent of the cone angle,

$D_0$  – the diameter of the sample tip before the wear test,

$D_1$  – the diameter of the sample tip after the wear test.

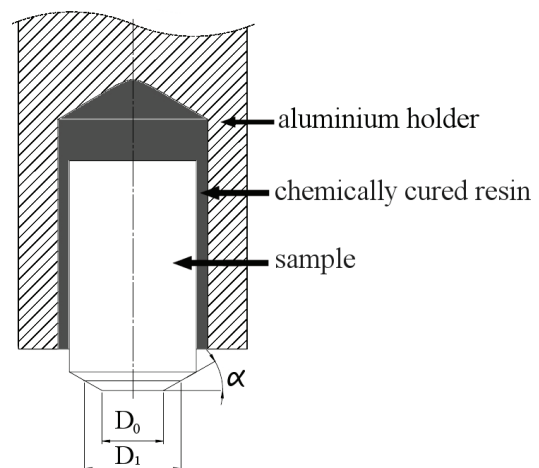

Fig. 5. Shape and dimensions of enamel samples (before testing)

The wear of the countersamples made of composite materials was assessed by measuring the volume of the wear scar taken with the aid of a confocal microscope. During the tests, samples that disclosed defects

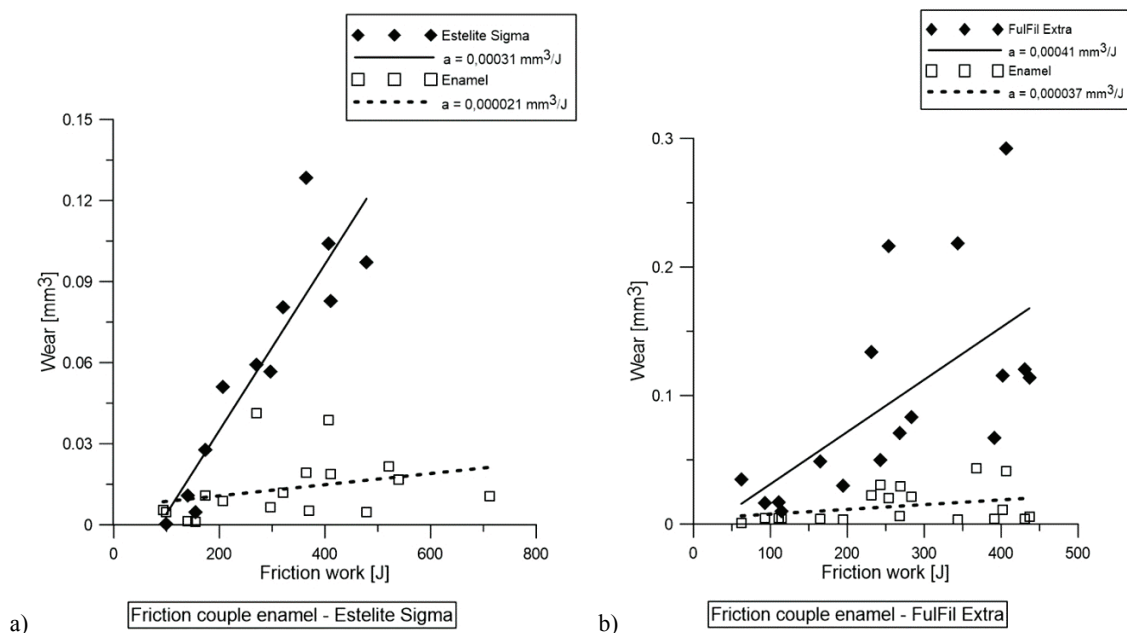

Fig. 6. (a) Wear of ES and (b) FFE materials in contact with the enamel as a function of friction work (a – slope of simple linear regression)

such as chipping or extensive pores likely to have significant effect on the wear process were eliminated from further tests.

The wear rates of the enamel samples were substantially lower than the wear rates obtained for both dental composites. The average value of the volume wear assessed for the pair enamel–ES was  $0.0128 \text{ mm}^3$  (enamel) and  $0.0666 \text{ mm}^3$  (composite); whilst for the pair enamel–FFE it amounted to  $0.0146 \text{ mm}^3$  (enamel) and  $0.0964 \text{ mm}^3$  (composite).

For preliminary interpretation of the test data scatter plots generated in the *Grapher* program were used (Fig. 6). For each series of tests a trend line was determined using a linear regression model, and the quality of the fit was assessed using the coefficient of determination –  $R^2$ .

Table 3. Values of specific wear energy of enamel and tested composite materials.

Values marked with the same letter show no significant statistical differences (Kruskal–Wallis test,  $p < 0.05$ )

| Tribological pair     | Specific wear energy ( $\text{J}/\text{mm}^3$ ); average values, standard deviations in brackets |                            |
|-----------------------|--|----------------------------|
|                       | Enamel – Estelite Sigma  | enamel                     |
| composite             |  | 4818 <sup>b</sup> (2742)   |
| Enamel – FulFil Extra | enamel   | 40282 <sup>a</sup> (35510) |
|                       | composite  | 4115 <sup>b</sup> (2587)   |

Table 3 contains the calculated means and standard errors. Since the distributions of specific wear energy

showed deviations from the normal distribution, the statistical significance of differences was verified by using the non-parametric Kruskal–Wallis test.

### 3.3. Microscopic observations of the surfaces formed during friction

Analysis of the enamel sample surface topography performed after the tribological tests using both optical and scanning electron microscopy have shown numerous changes that became visible in contact zones of the sample with the other element of the tribological pair (Fig. 7). The enamel surface formed in contact with the ES material is clearly smoother, unlike the enamel surface covered with many scratches after contact with the FFE material.

Using scanning microscope Hitachi S-3000N equipped with EDS microprobe the chemical composition of the enamel sample surfaces were analysed. The results of the analysis are shown in Fig. 9.

Based on the chemical analysis it can be concluded that both Sigma Estelite and FulFil Extra particles migrate to the surface of the enamel during friction. This is confirmed by the presence of such elements on the sample surface as Si, Ba, which are found in the composite fillers.

Figure 10 presents images showing wear tracks created on countersamples. Similarly to the enamel surface, numerous cracks and bumps resulting from friction were also found on the composite materials (Fig. 10c).

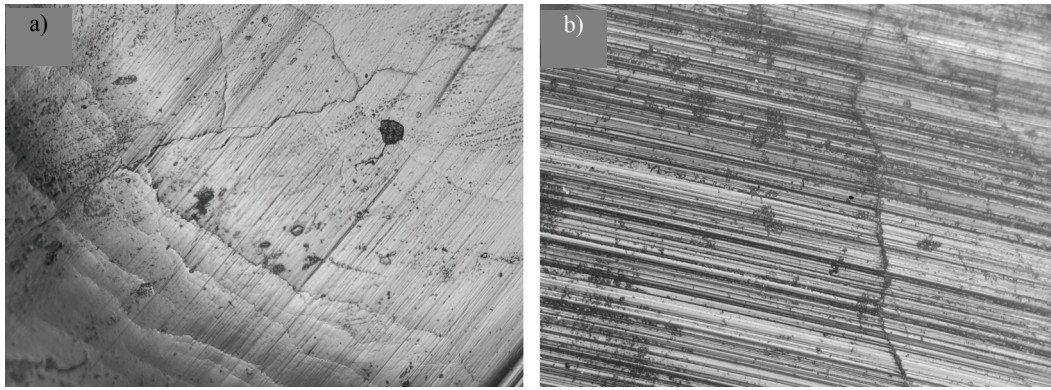

Fig. 7. Topography of enamel sample surfaces after contact with composites Estelite Sigma (a) and FulFill Extra (b) (optical microscope, 100×)

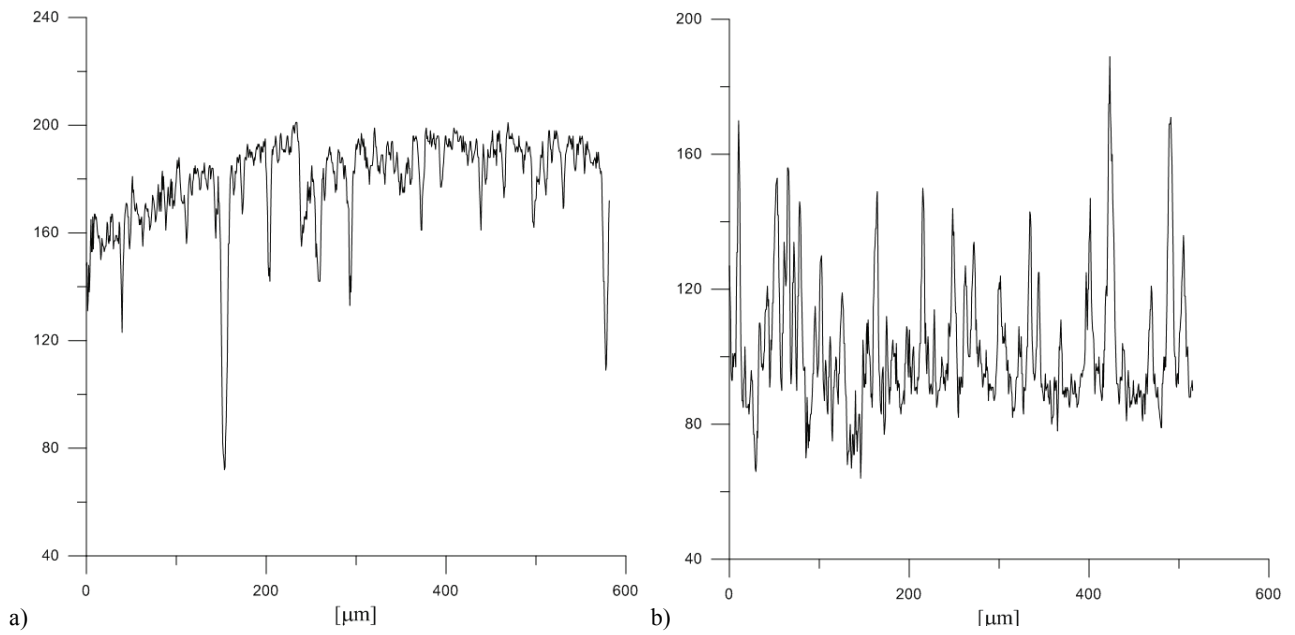
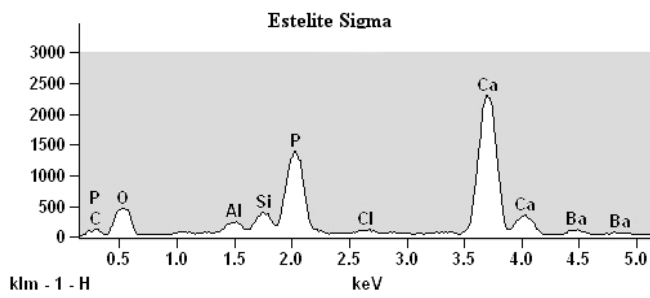

Fig. 8. Surface profile graphs of the enamel sample after contact with composites Estelite Sigma (a) and FulFil Extra (b)

Full scale counts: 2784



a) Full scale counts: 2933

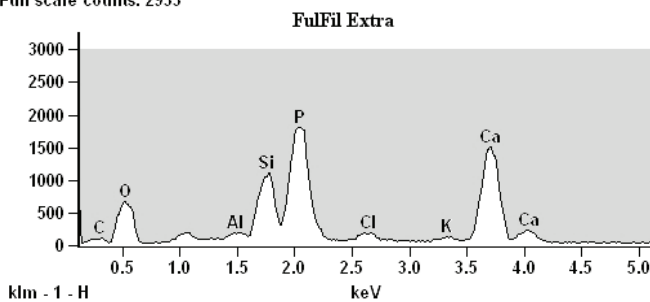

Fig. 9. EDS spectra of enamel surface after contact with composites Estelite Sigma (a) and FulFil Extra (b)

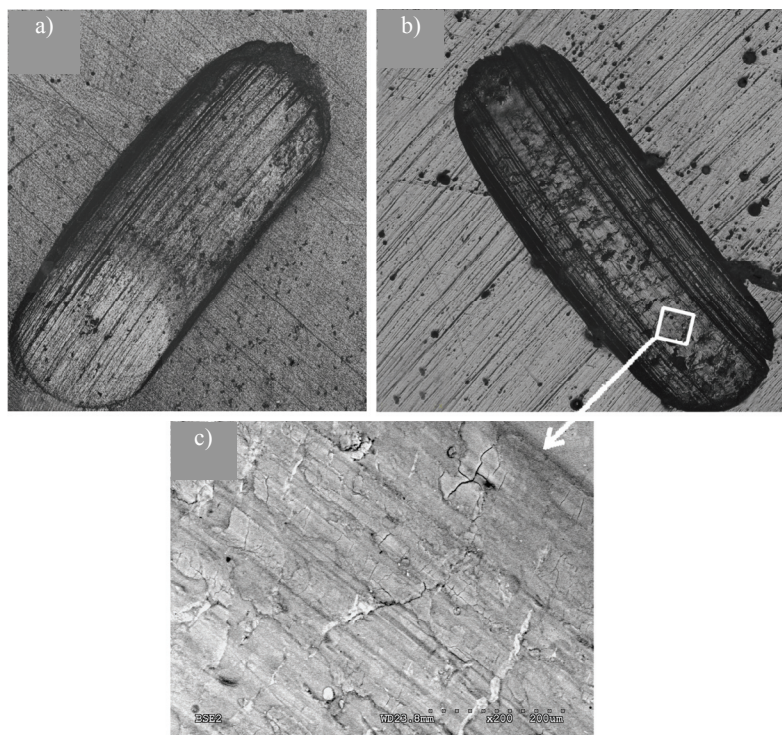

Fig. 10. Images of wear tracks (optical microscope, 50 $\times$ ): (a) FulFil Extra, (b) Estelite Sigma, (c) cracks on Estelite Sigma material (SEM, 200 $\times$ )

## 4. Discussion

The paper presents an analysis of the tribological characteristics of pairs: dental enamel–dental materials. Based on the results obtained, it was found that the value of the friction coefficient during the test is a subject to change showing a slight downward trend similar to ES and FFE dental composites. This is probably the effect of running-in of the tribological pair in the course of research [8], [15]. It should be noted here that some single step changes of the coefficient of friction to quite significant values, e.g., up to about 8 for ES and approximately 4 for the FFE. Considerable momentary variations of the friction coefficient occur periodically with frequencies of 1, 2 times per hundreds of cycles. However, it is not clearly visible on the graphs because of its compression. One of the possible explanations of this phenomenon is that the bigger filler particles are periodically pulled out from the surface layer of the dental material tested, and then an increase of friction occurs. These effects are probably due to the dynamic nature of the load, which involves periodic separation of the sample and countersample between load cycles.

One of the commonly used characteristics to describe materials is their resistance to wear caused by friction, i.e., tribological wear. The measure of this

resistance is the value of wear, which is generally expressed as an absolute value, namely by determining the loss in mass (by volume) of the material lost due to friction forces. Such an approach, although not devoid of some advantages, has one fundamental flaw since, even at nominally constant parameters, e.g., test load, sliding velocity, and it does not take into account the variability of the process of friction occurring during the test. In earlier work of one of the authors it was shown that the flaw can be significantly reduced by introducing the concept of a relative wear ratio, called specific wear energy [11]. This value is calculated as the ratio of friction work done (equal to dissipated friction energy) during the experiment to tribological wear, which is the result of this work. In other words, in this way we determine the value of the work that must be done by frictional forces to generate a volumetric unit of material loss. The value thus defined takes into account the changes of friction forces during the test and it is also a convenient indicator for comparing wear resistance of different materials or the resistance of the same material under different conditions.

As can be observed regression lines (Fig. 6) do not cross the origin of the coordinates system. According to the findings presented in the literature this is due to spending part of the friction work not only on generating wear products (new surface formation), but also

on the reactions taking place in the outer layer subjected to tribological interactions and also structural changes of the surface itself [4], [16]. The intersection of the trendline and the  $X$ -axis determines the value of the threshold work, which determines the processes of structural modification of the surface layer, which occurs prior to the formation of the first wear products. Diversified sloping of the regression lines indicates irregular wear intensity of the materials tested. The larger the angle of inclination of the regression line with respect to the  $X$ -axis, the lower the material resistance to tribological wear. Thus, the presented graphs show significant differences in wear resistance between the enamel and the composites used in the studies. However, this way of presenting data makes it difficult to determine the statistical significance of differences in wear resistance between the materials tested. In order to determine the significance of these differences we used previously defined specific wear energy (Table 3).

The data presented in Table 3 allow us to make a number of key statements concerning our research. Namely, the enamel has significantly better resistance to wear than the composite materials tested. However, the resistance is not directly dependent on the type of dental material used in the study. The difference in the values of specific wear energy observed between FFE and ES materials proved to be statistically insignificant. A considerable dispersion of the measurement results could be noted, i.e., large standard deviation with regard to the mean value, the fact which undoubtedly influenced the significance of the test results. The scattering of the results involving enamel–composite material couples is due, among others, to their high sensitivity to random phenomena that occur during tribological tests [14]. This shows both how methodically difficult this type of research can be, and hence, providing stable conditions for research is of crucial importance here.

The values of specific wear energy obtained in the present work point to advantageous tribological properties of the new composites, as the wear resistance measured this way is at least an order of magnitude smaller than that of other materials. Moreover, they cause the wear intensity of the opposite enamel samples to decrease several times, as compared with the data presented in another paper on the subject [11].

Surfaces formed during the process of friction were observed with various microscopes (Fig. 7). It is clear that the enamel surface after contact with the material ES is smoother. This is confirmed by profile lines generated using a BX51 optical microscope (Fig. 8). We

can infer that in the case of the FFE material the abrasive wear is more intensive than in that of ES. This is undoubtedly related to the shape of the filler particles which have the spherical shape in the ES material. Hence probably a little higher intensity of wear, i.e., lower wear resistance of the FFE material.

The wear of tooth enamel is a complex phenomenon involving different processes. Hardly ever any of these processes occur singly. Nevertheless, one process usually dominates, and hence the wear may be manifested in a different way, and as a result variations of the enamel roughness can be observed. The topography of enamel surface formed during tribological testing crucially depends on the size and shape of filler particles, when enamel is tested paired with composite dental materials. Particularly, filler particles having sharp edges contribute to a larger share of abrasive wear mechanism; hence the higher values of the roughness are created. According to the data provided by the manufacturers of composite materials used in the studies, ES composite contains fillers of spherical shape, whilst FFE contains non-spherical filler particles. Due to the above, the participation of abrasive wear mechanism was less significant for the former material, than for the latter one. The shapes of fillers influence not only the roughness of enamel surface, but also lead to an increase of enamel wear rate. Considering the results of the studies, filler particles with spherical shape should be used in practice in order to reduce the destructive effects of dental materials on tooth enamel.

Figure 10 shows the differences in the surface appearance of both composites, they seem to have been due to differences in the mechanisms of wear.

The results of microscopic examination and analysis using EDS unequivocally reveal interactive work of the material surfaces in contact not only on the physical, but also to a significant degree, on the molecular level. The presence of the characteristic transformation of the surface layers of the tested materials resulting from frictional interactions are similar to those described elsewhere [8]–[10].

## 5. Conclusions

The paper analyses tribological properties of enamel and two composite materials used for permanent dental fillings, i.e., Estelite Sigma and FulFil Extra. They were subjected to kinematic interaction as a dental material–enamel paired couple on a specially designed friction simulator of the pin-on-disc type.



To interpret the results, the energy criterion, i.e., specific wear energy was used. In addition, optical and scanning electron microscopy was used to observe the surface topography of both enamel sample and countersamples made from dental composite materials – FulFil Extra and Estelite Sigma. As a result of the analysis the following major conclusions can be formulated:

- tribological wear resistance of the dental materials investigated in this work is lower than the resistance of dental enamel – as yet there are no satisfactory alternative materials to replace enamel;
- composite materials such as Estelite Sigma and FulFil Extra are characterized by greater resistance to wear and are less destructive to enamel than the material investigated by the authors earlier;
- enamel surface topography depends significantly on the type of material used in tribological tests and indicates a greater share in abrasive wear of FulFil Extra,
- it can be assumed that the spherical shape of the filler particles (Estelite Sigma) has a beneficial effect in reducing enamel wear. However, this statement requires confirmation by statistical analysis using more extensive study material.

### Acknowledgement

The authors wish to thank Mr. Tomasz Koziółkiewicz for his assistance with various phases of the experiments.

### References

- [1] ANTUNES P.V., RAMALHO, *Study of abrasive resistance of composites for dental restoration by ball-cratering*, *Wear*, 2003, 255, 990–998.
- [2] CONDON J.R., FERRACANE J.L., *Factors effecting dental composite wear in vitro*, *J. Biomed. Mater. Res. (Appl. Biomater.)*, 1997, 38, 303–313.
- [3] DWORNICKA K., KUPKA T., SKABA D. et al., *Materiały do wypełnień we współczesnej dentystyce odtwórczej*, Ośrodek Wydawniczy “Augustana”, Bielsko Biala, 2003, 58–60.
- [4] FOUVRY S., LISKIEWICZ T., KAPSA P.H., HANNEL S., SAUGER E., *An energy description of wear mechanisms and its applications to oscillating sliding contacts*, *Wear*, 2003, 255, 287–298.
- [5] GAL J.V., FOVET Y., ADIB-YADZI M., *About a synthetic saliva for in vitro studies*, *Talanta*, 2001, 53, 1103–1115.
- [6] HABELITZ S., MARSHALL G., BALOOCH M., MARSHALL S.J., *Nanoindentation and storage of teeth*, *J. Biomech.*, 2002, 35, 995–998.
- [7] HEINTZE S.D., ZAPPINI G., ROUSSON V., *Wear of the dental restorative materials in five wear simulators results of a round robin test*, *Dent. Mater.*, 2005, 21, 304–317.
- [8] MYSTKOWSKA J., DĄBROWSKI J.R., *Tribological characteristics of the kinematics couple: tooth – composite material for permanent dental fillings*, *Maintenance and Reliability*, 2010, 3, 4–19.
- [9] NAGARAJAN V., HOCKEY B.J., JAHANMIR S., THOMPSON V.P., *Contact wear mechanisms of dental composite with high filler content*, *J. Mater. Sci.*, 2000, 35, 487–496.
- [10] ROSENTRIT M., BEHR M., HOFMANN E., HANDEL G., *In vitro wear of composite veneering materials*, *J. Mater. Sci.*, 2002, 37, 425–429.
- [11] SAJEWICZ E., *A comparative study of tribological behaviour of dental composites and tooth enamel: an energy approach*, *P. I. Mech. Eng. J.-J. Eng.*, 2010, 224, 559–568.
- [12] SAJEWICZ E., KOZIÓLKIEWICZ T., *Wpływ wybranych materiałów stomatologicznych na zużycie szkliwa*, *Mechanika w medycynie, Zbiór prac seminarium naukowego 4*, Rzeszów 1998, 45–248.
- [13] SAJEWICZ E., KULESZA Z., *A new tribometer for friction and wear studies of dental materials and hard tooth tissues*, *Tribol. Int.*, 2007, 40, 885–895.
- [14] SAJEWICZ E., *Tribological behavior of human enamel in red wine and apple juice environments*, *Wear*, 2007, 262, 308–315.
- [15] SAJEWICZ E., *Tribologiczne aspekty funkcjonowania narządu zębowego człowieka*, *Rozprawy Naukowe 150*, Wydawnictwo Politechniki Białostockiej, Białystok, 2007.
- [16] SAJEWICZ E., *Wprowadzenie do biotribologii*, Oficyna Wydawnicza Politechniki Białostockiej, Białystok, 2011, 100–134.
- [17] SARCEV I.N., PETRONIJEVIC B.S., ATANACKOVIC T.M., *A biomechanical model for a new incremental technique for tooth restoration*, *Acta Bioeng. Biomech.*, 2012, 14, 85–91.
- [18] SZAFRAN M., BOBRYK E., SZCZĘSNA B., JALBRZYKOWSKI M., *Wpływ dodatku nanowypełniacza na właściwości mechaniczne i tribologiczne kompozytów ceramiczno-polimerowych do zastosowań stomatologicznych*, *Wydawnictwo Politechniki Częstochowskiej, Kompozyty (Composites)*, 2006, 3, 83–87.
- [19] TOMANKIEWICZ M., MIELNIK-BŁASZCZAK M., *Materiały kompozytowe i szklano-jonomerowe w praktyce stomatologicznej*, *Wyd. Czelej, Lublin*, 2002.