

Evaluation method of saliva and oral cavity mucous membrane in the aspect of holding a denture on an atrophic base

WIESŁAW CHLADEK

Research Group for Medical Engineering, Silesian Technical University,
40-019 Katowice, ul Krasińskiego 8, Poland

TOMASZ LIPSKI, JACEK KASPERSKI

Chair of Stomatological Prosthetics, Silesian Medical Academy in Katowice,
Bytom, pl. Akademicki 17, Poland

The paper presents application of the authors' own method of investigating the secretion and elasticity of saliva as well as resilience of mucous membrane in evaluation of force holding the lower denture in the base. The object of research is a complete mucus lower denture cooperating with the base with a tooth-caving that is on the decline. Results of the tests of a horizontal force knocking the denture off the base were assumed as objective effectiveness evaluation criteria. Clinical investigation has been carried out in a group of 126 patients using diagnostic devices constructed according to the authors' own conception. The elasticity of saliva was determined by measuring the length up to the break point where saliva loses elasticity, the sample volume being 55.26 mm³. The amount of saliva was determined on the basis of the area on which saliva remains and that is created by pressing the saliva with a force of 140 N by means of a 0.22 mm thick circular filter paper with a diameter of 8 mm. The filtering paper had earlier been put for 30 seconds on a mucous membrane in the area of molars. The resilience was determined on the basis of the penetrator's cavity dented by a force of 1 N into the mucous membrane. Results obtained during the examination of a group of patients enabled an unambiguous numerical description of the characteristic features of oral cavity environment. A statistically significant influence of all investigated factors on the force necessary to knock the denture off the base has been determined. A significance hierarchy of the factors investigated as well as the ranges of variability in the parameters measured have been defined. The resilience of the mucous membrane has affected the denture knocking off force the most. It had a value of 0.4 mm up to 2.1 mm during an impact of a pointwise pressure of an average value of 0.99 mm. Then, the influence of the amount of the secreted saliva has been observed. The amount of the saliva gathered on the filter paper was expressed in terms of a "flood" area obtained after pressing the paper and amounted to 180 mm² up to 660 mm², with the average of 468.75 mm². The least important factor was the elasticity determined by the break length of a saliva sample. The lengths of breakpoints measured were from 4.8 mm for saliva with a dominant serum secretion content up to 24.1 mm for saliva with a dominant mucus secretion content. The average value for the whole population examined was estimated at 14.19 mm.

Key words: secretion and elasticity of saliva, resilience of mucous membrane, force holding denture

1. Introduction

Counteracting any difficulties connected with sustaining lower complete dentures on an atrophic denture bearing area is strictly connected with prior definition of factors influencing functional characteristics of the denture–oral cavity environment system. The related bibliography available shows that there is

general awareness of the necessity of determining mutual relationships between the factors which have major influence on the comfort of using such dentures [1]–[3], [5], [6], [13]. The studies carried out concern practically the entire denture area including the status of mucous membrane and viscosity as well as the amount of saliva [7], [8], [11], [12], [14]. There are, however, various criteria used for the evaluation, starting with descriptive ones based on visual or pal-

pable examination made by a doctor and ending with measurements based on laboratory procedures employing specialized and costly devices. Such a situation does not favour creation of any complex solutions. A prerequisite of progress here is the use of cheap and fast diagnostic tests, which enable a univocal description of the denture area characteristics. In this work, the authors present three new methods they have invented to diagnose the denture area, and describe the effects of using them for examination of people with the oral cavity showing unfavourable conditions for sustaining the lower denture complete. Results of the evaluation of given denture bearing area parameters have been associated with stability of dentures. The force that knocks the denture off the denture bearing area was assumed to be the basic criterion for stability evaluation.

2. Methodology

Prior to the clinical survey some criteria had to be defined for choosing patients with the required denture area. The basic condition was a complete lack of teeth treated by means of prosthetics for a period not shorter than three years. Out of this group only those cases were chosen for which it was difficult to sustain denture due to alveolar ridge atrophy. Before making the choice a number of clinical cases had been observed in which a lower complete denture was the cause of much discomfort. The period the particular dentures were used by patients was 3 to 5 years, regardless of the entire period in which those people had been afflicted by the toothlessness. The surveys included 126 people aged 42 to 88, in which the maximum period of using complete dentures did not exceed 21 years.

Each of the patients has been informed about the aim of the survey and instructed how he/she should prepare for a visit, during which the measurements were to be carried out. Of vital importance were the time of the visit which was set to take place in the morning (i.e., before 12 a.m.) and a request not to eat a square meal before and to stop eating at least two hours before the visit.

The authors got acquainted with the existing knowledge related to the factors they were to examine. The status of oral cavity mucous membrane is an individual characteristic that varies a lot independently of patient's age and sex, or the fact of whether or not a patient uses a denture. The degree of deformation of the mucous membrane under pressure as well as the quality of the mucus film lying on it are as-

sumed to be the most characteristic features describing the mucous membrane. Under point pressures, the deflection of the mucous membrane, depending on the place of measurement and individual features, oscillates between 0.4 and 2.8 mm and in general, during a routine examination of the area, is estimated on the basis of a non-dimensional descriptive scale. The basic factors defined in order to classify saliva's characteristics as far as their co-operation with mucus denture is concerned are its [15] viscosity and the pace of secretion [16], [20]. Viscosity and resilience of saliva as well as its amount connected with the pace of secretion are individual features varying a lot from patient to patient. A conventional measurement in testing the pace of secretion is the expectoration method [10], [11], assumed to be the most productive one [4]. Patient spits the saliva to a special container, which is then weighted with an accuracy up to 1 mg. The saliva mass is then divided by the time of the measurement and the result thus obtained is the speed of saliva secretion given in g/min [10], [19]. This is quite a time-consuming method, which hinders its widespread use.

In work [9], an attempt was made to simplify the method of saliva secretion speed measurement using circle-shaped blotting paper with 8 mm in diameter, as saliva storage medium. The blotting paper was placed on both sides of the palate in the area of the second molar tooth, approximately 15 mm to the toothless ridge. The saliva was being collected for 30 seconds. The weight of the saliva was given in $\mu\text{L}/\text{min cm}^2$, assumed to be the equivalent of $\text{g}/\text{min cm}^2$. The accuracy of the sample weight measurement is very important here. Additional difficulty arises when it comes to the sample storage procedure which is quite complicated as protection against drying up is to be ensured. Thus, the method cannot to be used out of the laboratory.

One obvious conclusion drawn by the authors is that along with the development of knowledge about the role of saliva in a prosthetic treatment no such development has been observed as regards appropriate apparatus that would enable its diagnosis [17], [18]. There is still lack of simple, univocal methods for defining the amount and viscosity as well as resilience of the secreted saliva.

While working out their own methods of saliva examination, the authors assumed that the measuring technique ought to be simple, not requiring any expensive instrumentation and that it should be possible to apply it in conditions of any dental surgery.

The authors decided to use for the testing of secreted saliva the above mentioned [9] disc of 8 mm in

diameter cut out of a 0.22 mm thick filter paper. Following the methodology of [9], the discs were placed for 30 s within the area of molar teeth. Further on the authors used their own concept of simplifying the measurement. Instead of weighing the samples, the saliva was squeezed out of the soaked paper immediately after the samples had been removed from the oral cavity. The sample was put into a small PE L-type envelope and pressed with a manual press. The amount of secreted saliva was determined by evaluating the saliva spill area, i.e., the area of its spread. During the primary tests the minimum pressing force was fixed at a level of 140 N and a maximum spill area was defined, constituting the upper border to which the pressed saliva was spilled. It was a circle with a diameter of 32 mm. In order to enable a quick quantitative evaluation of secreted saliva, the following solution has been implemented: a comparative shield/target was constructed, on which the central point (where sample was to be placed) was a circle of a diameter of 8 mm, then six rings were drawn, each having the area of 120 mm^2 . The whole was divided with lines indicated every 45° , into 48 segments, 15 mm^2 each. The comparative pattern obtained consisted of rings of various diameters and widths, although, each having 8 similar fields. On the pattern thus prepared the pressed film with saliva sample was placed and illuminated till the moment of obtaining a clear reflection of the spill area. Subsequent phases of the test are illustrated in figure 1. Putting the saliva sample into a PE envelope immediately after having it removed from the oral cavity protects the sample against losses of saliva before placing the sample under press. For the pressure to be uniformly distributed on the sample surface, both plates of the press had been coated with an elastic lining, as shown in figure 2a. After pressing, due to the capillary effect the stability of the saliva spill area sustained for the period required to accomplish the measurement. A typical saliva spill area is shown in figure 2b. Irrespective of the shape of saliva spill area the number of the segments being covered was counted and multiplied by 15 mm^2 .

One of the important factors for denture sustaining is the resilience of saliva. Although, in general, it should not be difficult to differentiate between serum and mucus saliva, there has not been developed any simple method of evaluating the quality of saliva in this aspect. Because of the considerable complexity of description of rheological phenomena, the authors decided not to use any liquid viscosity measurement methods. A simplified, but effective method has been put forward. It consists in defining the length the saliva sample of a given volume can be elongated till the

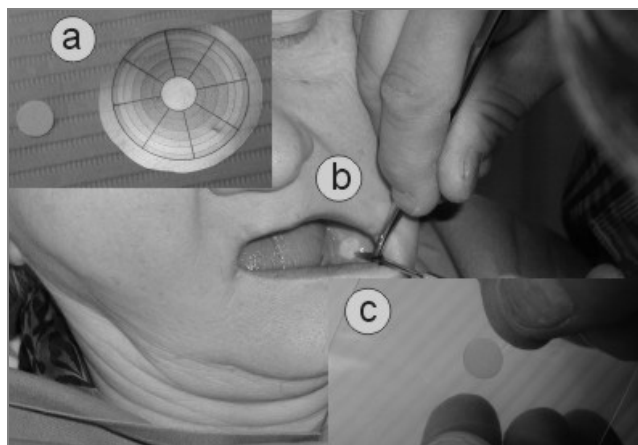

Fig. 1. Measuring technique for estimation of the secreted saliva: a – view of a dry sample and a ruler, b – method of sample positioning in oral cavity in order to make it soaked, c – a view of an envelope with a soaked sample inside

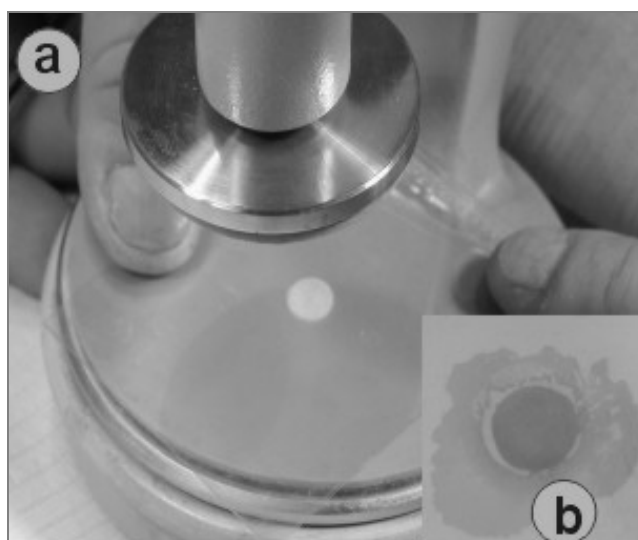

Fig. 2. View of the envelope with the sample: a – positioned on the press plate, b – after the saliva pressing

moment it gets ruptured. As a load bearing structure electronic calipers were used. The calipers enabled length measurement with the accuracy of 0.02 mm. Special cover plates were installed coaxially on the arms of the calipers. The upper one was a flat-ended cylinder of a diameter of 9 mm, in lower one of the external diameter of 10 mm, a 8 mm large and 1 mm deep nest was milled out. The total volume of the nest equalled 50.26 mm^3 . Under the contact surface, in the lower cover plate there was a neck, into which a rubber flange was installed. The latter protected the device against staining by the saliva that might get into the area where it should not be present. The first step of the test was to fill the nest with an overflow of saliva. Then, both contact surfaces were pressed together making the excess of the saliva flow out. After

having collected the surplus of the saliva with blotting paper the sample was tensed/elongated. The calipers were installed in a grip of a pulling device equipped with a line. The end of the line was attached to a screw of the brake of the movable element of calipers and then the pulling device was started. The speed of winding up the line was 2 mm/s. A stretched saliva sample is shown in figure 3. The moment the sample got ruptured, the pulling device stopped operating and the length to which the sample had been stretched was read.



Fig. 3. Saliva sample under tensile force

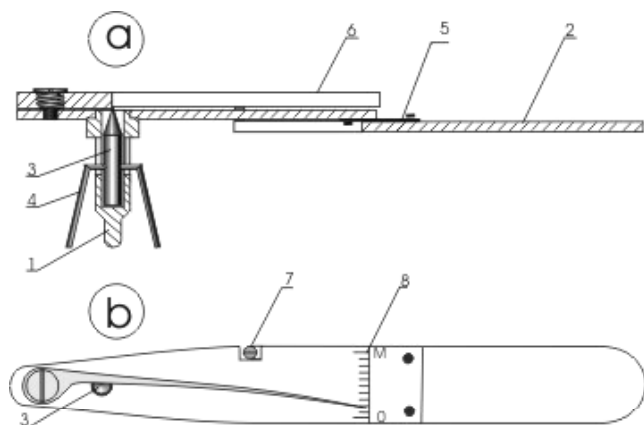

Fig. 4. Scheme of the device used for testing the susceptibility of the oral cavity mucous membrane: a – cross-section, b – the position of the indicator after the measurement

In clinical practice, resilience of the mucous membrane is usually estimated on the basis of palpable test or on the basis of membrane's reaction to pressure caused by a ball-stuffer. This results mainly from the lack of simple devices enabling quick and uniform measurement. A scheme of the device proposed is

presented in figure 4; figure 4a shows schematically the cross-section of the mechanism, and figure 4b presents the device with the indicator blocked after measurement.

The element that impacts the mucous membrane is a pin (1) ended with a ball-intruder, fixed on a two-piece handle (2) of the device. Inside of the pin there is a moving bolt (3) ended with a cone. The bolt is connected with the side resistance edges (4). These edges, in their primary position, reflecting zero deflection of the mucous membrane are located at the same level as the ending of the penetrator. On the handle of the device constructed of two fragments connected with a flat spring (5), behind the axis of the pin, there is installed a lever, which is at the same time the indicator (6), which is pressed by the spring to the protruding cone top. Before starting the measurement the lever is to be pushed back with a thumb until it hooks on the force limit trigger (7), then the intruder is pushed on the mucous membrane. Drawing the lever back to the point corresponding to the maximum value on the scale enables movement of the slide with edges, smoothly without resistance. Upon pressing intruder, the edges remaining on the non-deflected surface of mucous membrane move the pin protruding the bolt further and further above the surface of the handle. At the same time, due to the deflection of the spring connecting both elements of the handle, the trigger of the dynamometer fixed to the handle part is being slowly pulled. As the pressure reaches 1 N, the trigger releases the lever, which wedges the cone and blocks the whole measuring system. Depending on the degree of protrusion of the cone at the moment the device has been blocked, the angle of the lever changes. Dislocation of the lever corresponds to the depth the intruder has reached in the mucous membrane which is shown on the scale (8) placed on the handle.

The parameters of the denture bearing area have been numerically defined in order to point out the relationships between the condition of the denture bearing base and the horizontal forces causing the denture to knock off the bearing area. Such forces might be generated with the tongue, lips or they can result from dynamic loads of the denture. Tests of the force that knock the denture off the denture bearing base have been carried out by means of an electronic dynamometer TesT Push Pull Gauge model 320 with the scale of up to 200 N. The basic gauge is equipped with a digital scanner, memory with simultaneous differentiating between maximum and minimum forces as well as a socket enabling direct data transmission to a computer. This device has been additionally equipped with shaped endings that enable hooking of the

device onto the incisor teeth of the denture. The device with a wide ending is presented in figure 5.



Fig. 5. Electronic force gauge TesT model 320: a – general view of the gauge with a contact tip enabling hooking up the incisors, b – side profile of the tip

While planning this experiment, it was assumed that the only one strict connection between saliva resilience, its amount and the force knocking the denture off the bearing base, all defined under the same conditions, enables evaluation of potential relationships between those factors. Hence, apart from elaborating quick diagnostic methods, it was necessary to define a proper sequence of tests. First, the denture knocking off force was tested, followed by the saliva resilience test, then after flushing the oral cavity and a two minute pause the amount of the secreted saliva was measured and finally, resilience of the mucous membrane was tested. It is of vital importance that all the factors be analyzed in the shortest possible time, so that any changes of the status relative to the knock-off of the denture would be the smallest. The overall time of examination of one patient did not exceed 12 minutes, so that the status of oral cavity environment could have changed very slightly during the tests.

3. Results and discussion

Use of the above devices enabled numerical description of the features of the oral cavity environment. In particular tests, the results obtained ranged as follows:

- In 6 cases, the amount of secreted saliva, given in terms of the saliva spill area, was less than 240 mm², for 27 patients it was bigger than 600 mm², with the average value of saliva spill area being equal to 468.75 mm².

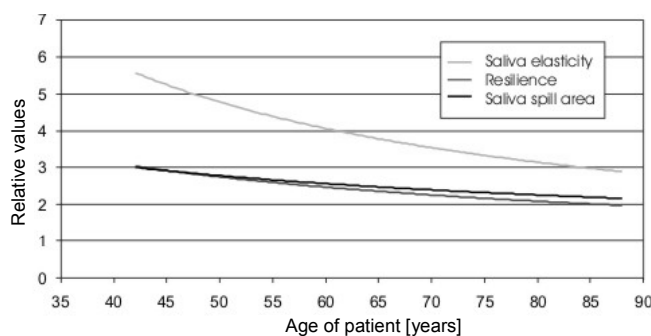

Fig. 6. Influence of the age on relative values describing changes in the status of denture area

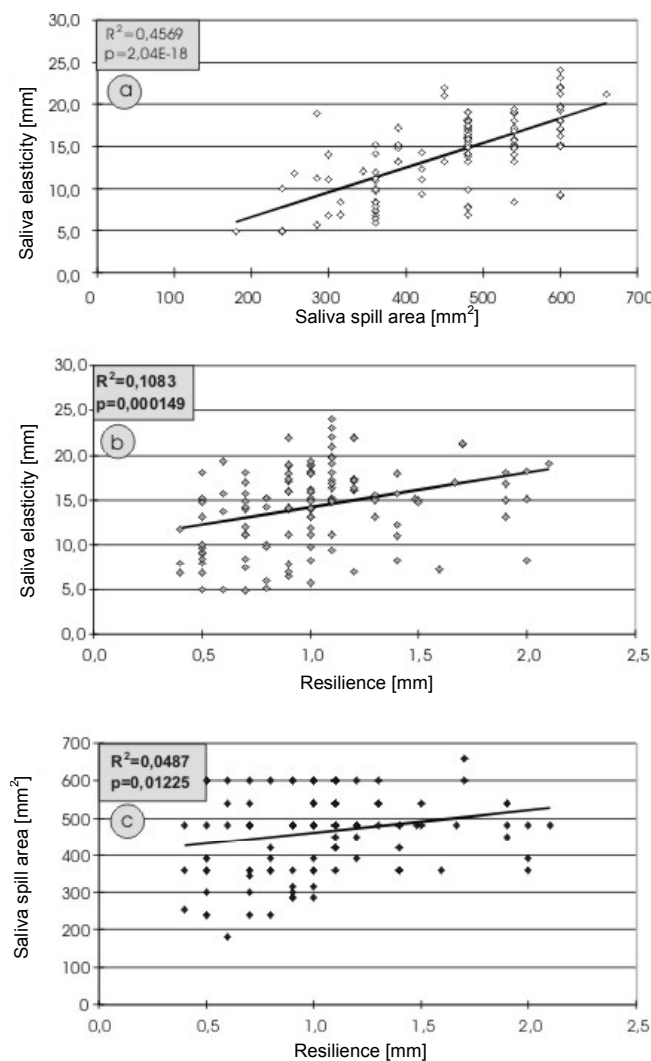

Fig. 7. Mutual relations between the parameters describing the status of the prosthetic area: a – relationship between saliva elasticity and the size of saliva spill area, b – relationship between saliva elasticity and resilience of the mucous membrane, c – relationship between the size of the saliva spill area and the resilience of the mucous membrane

- As regards the elasticity of saliva, in 4 patients the rupture length of saliva sample was 5 mm, in 17 cases it varied from 20 to 25 mm, the average

value for the whole population being estimated at 14.19 mm.

- Resilience measured by means of the method proposed changed by 0.5 mm and less (16 cases) to the value of 1.9 to 2.1 mm (8 cases), with the average value of 0.99 mm,

The first factor analyzed was the influence of the age of a toothless patient being examined on environment of the oral cavity. In order to enable simultaneous comparison of all the parameters tested, a non-dimensional description of the changes of resilience, amount and rupture length of the secreted saliva has been applied. To this end, the results of particular tests were divided by the worst result obtained in a given population. Relative values have been obtained in this way. These are shown as a function of age on a chart of figure 6. Owing to the simplifications made (such as, for instance, separation of 15 mm² unit segments from the saliva spill area) it was possible to get repeatable results. Therefore, often one point represents a few measurements on the diagrams. In order to have a clear picture of the phenomena tested, trend lines defined according to a power function have been inserted in particular charts. The lines that reflect changes in environment parameters due to the age of patients have proved a systematic deterioration of denture functioning conditions along with the general ageing process of the whole organism. As one can see, age has the greatest effect on changes in saliva elasticity, whereas the least on those of the resilience.

In order to find mutual relationships between elasticity, amount of the secreted saliva and resilience, a statistical analysis or correlations and linear regression have been applied. The results are shown in three charts of figure 7. On each of the diagrams values of R^2 are given providing information about the spread of results and rating of statistical importance level "p". Diagrams are presented in the decreasing order of statistical significance, assuming $p(\alpha) < 0.05$. In all the cases, a statistically significant relationship between the measured parameters has been proved. Emphasis is put on the relationship between the amount and elasticity of saliva (figure 7a), second is the relationship between resilience and elasticity (figure 7b), and finally, the relationship between the resilience and the amount of the secreted saliva (figure 7c). There are visible large spreads of results making it even more difficult to draw uniform conclusions putting aside all statistical analyses. This can be best seen from diagram 7c, where in the full range of measured resilience values, there are cases of profuse secretion of saliva. In this case, the result of statistical analyses followed from the systematic increase of minimum values with an increase of resilience.

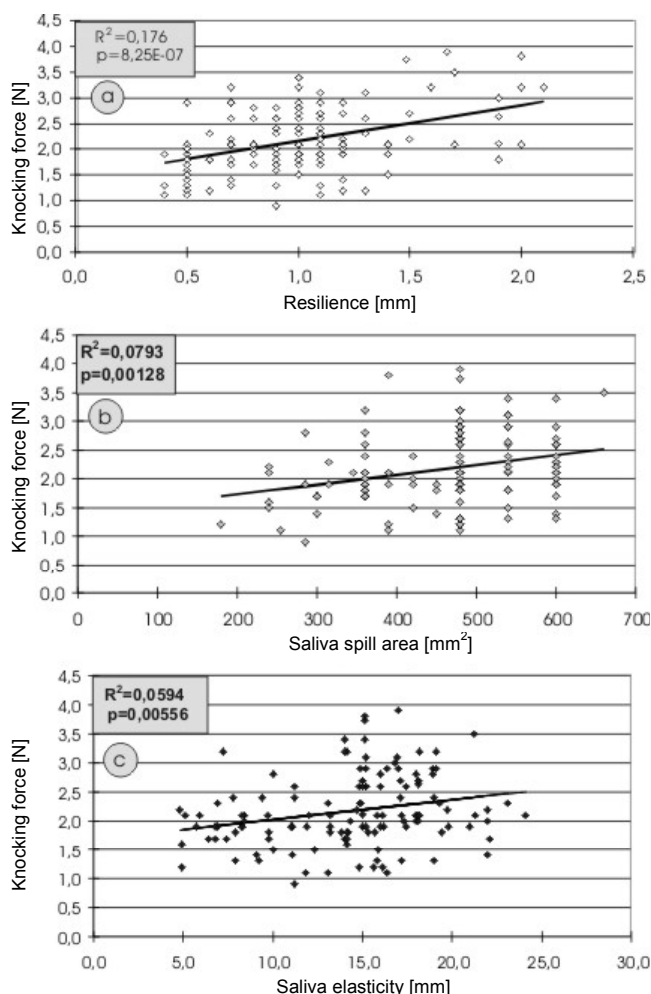

Fig. 8. Values of the force that knocks the denture off the denture bearing area relative to: a – resilience of the mucous membrane; b – amount of saliva defined by the size of saliva spill area, c – tension rate of saliva

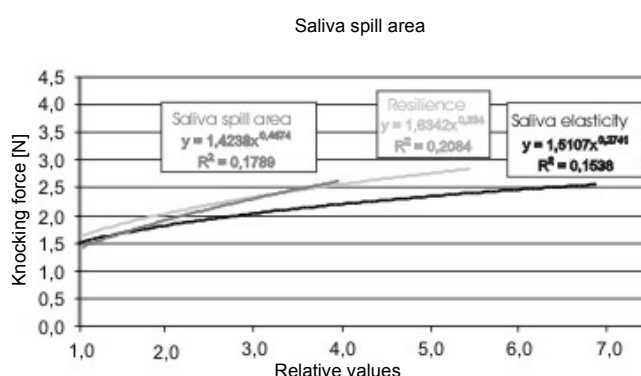

Fig. 9. Trend lines describing the relationship between the force that knocks the denture off the denture bearing area and relative values of resilience changes, amount of the secreted saliva and its elasticity

Using a similar technique of analysis the results, in figure 8, diagrams are juxtaposed that describe the influence of particular parameters on the force that

knocks the denture off the bearing area. In all the cases, it has been pointed to a considerable statistical significance of the relationship between the force knocking off the denture and the tested features of oral cavity environment. The increase in values of the evaluated parameter positively affected the ability of sustaining the denture in the bearing base. From the classification made according to the statistical importance level and the spread of results it follows that the resilience of the mucous membrane has the most positive influence on denture sustaining in the base. As shown in figure 8a, along with an increase of resilience, both minimum and maximum denture knocking-off force values increase. The amount of secreted saliva was in a given population the second most significant factor that decides of whether or not the denture is sustained in the base. It is worth mentioning here that the maximum denture knocking-off force values increase almost by three times, whereas the minimum values change insignificantly, which is illustrated in figure 8b. The least statistically significant as far as sustaining of the denture in the base is concerned is the elasticity of saliva. A diagram and data listed in the figure 8c show that even huge changes of saliva elasticity are not necessarily accompanied by uniform changes of the forces counteracting the knocking-off of the denture. In order to make the comparison of results easier, in figure 9, the trend lines set according to the power function are compared. These lines show relationship between the force that knocks the denture off the base and relative values calculated on the basis of the method described. Additionally, there are given equations of curves and values of R^2 . For evaluation purposes, in this case, power exponents and equation constants can be used. Interpretation of the results confirms the established hierarchy of the factors tested regarding their influence on the force that sustains the denture in the base. However, it appears that the differences are significantly smaller than those one might have assumed based on of the former evaluation of the statistical significance level.

The large variability of results evidenced by low R^2 values proves the necessity to carry out more thorough studies of its causes. The broad extent of the issue requires further division into partial problems taking into account, for instance, a detailed classification of denture area topography, influence of illnesses, influence of smoking, hygiene of oral cavity or the type of diet. It is a symptomatic fact that in the population being examined, the period of using prosthetic supplements has not significantly affected the status of oral cavity environment. This can be explained by

the fact that only people who have not complained about using their dentures were invited to take part in the survey.

4. Résumé

The substantial tasks of the present work were the construction of devices and elaboration of adequate methodology for examination of denture area of patients afflicted by a complete toothlessness. The authors have made improvements in this regard. Devices used for testing mucous membrane resilience, rupture length of a saliva sample and the amount of the secreted saliva enable quantitative description of the parameters measured. Abandoning the methods of pure estimation used up to now, we are able to carry out systematic surveys/tests while assuring repeatable results. It is worth mentioning here that only connection of complete and uniform diagnostic information with systematic recommendations regarding the construction and exploitation of dentures enable an increase of their durability and setting directions for further studies.

The limitation of clinical studies only to the cases of atrophy of the alveolar ridge was meant to lower to minimum the influence of the distribution of forces on the slopes of alveolar ridges on test results. However, it is practically impossible to get identical biomechanical conditions determined by the topography of denture area. This fact might have an impact on obtaining denture knocking-off forces during work. Limiting the duration of tests one can decrease as much as possible the influence of changeability of physical conditions in oral cavity on their results. Such status favours a significant spread of test results. Despite those difficulties, the tests carried out enable the following classification of the importance/impact of oral cavity environment parameters on denture sustaining conditions:

- a) the factor that exerts the greatest influence is the resilience of the mucous membrane,
- b) second to the above is the amount of secreted saliva,
- c) saliva consistence defined by the sample rupture length proves to be the least important factor in this respect.

Such a hierarchy proves the purposefulness of routine relining of dentures cooperating with the base in difficult prosthetic conditions. Soft relining compensates for the shortages of one's own mucous membrane. The studies carried out point out the biostatic role of the liq-

uid film separating the denture from the denture bearing area. The results obtained confirm legitimacy of using preparations increasing saliva's resilience/elasticity and operations improving humidity of oral cavity.

Acknowledgement

This work was supported by the State Committee for Scientific Research (KBN) under grant No. 3 T11E 02029.

Bibliography

- [1] BARDOW A., NYVAD B., NAUNTOFTE B., *Relationships between medication intake, complaints of dry mouth, salivary flow rate and composition, and the rate of tooth demineralization in situ*, Arch. Oral. Biol., 2001 May, 46(5), 413–423.
- [2] CHRISTERSSON C.E., LINDH L., ARNEBRANT T., *Film-forming properties and viscosities of saliva substitutes and human whole saliva*, Eur. J. Oral. Sci., 2000 Oct, 108(5), 418–425.
- [3] COMPAGNONI M.A., SOUZA R.F., LELES C.R., *Kinesiographic study of complete denture movement related to mucosa displacement in edentulous patients*, Pesqui Odontol Bras., 2003 Oct–Dec, 17(4), 356–361.
- [4] DAWES C., *Physiological factors affecting salivary flow rate, oral sugar clearance, and the sensation of dry mouth in man*, J. Dent. Res., 1987, 66(Spec. No.), 648–653.
- [5] HARA T., SATO T., NAKASHIMA K., MINAGI, *Effect of occlusal pressure on the histopathological changes in denture supporting tissues*, J. Oral. Rehabil., 1996 Jun, 23(6), 363–371.
- [6] HIRVIKANGAS M., POSTI J., MÄKILÄ E., *Treatment of xerostomia through use of dentures containing reservoirs of saliva substitute*, Proc. Finnish Dent. Soc., 1989, 85, 47–50.
- [7] KAWANO F., ASAOKA K., NAGAO K., MATSUMOTO N., *Effect of viscoelastic deformation of soft tissue on stresses in the structures under complete denture*, Dent. Mater. J., 1990 Jun, 9(1), 70–79.
- [8] KAWAZOE Y., HAMADA T., *The role of saliva in retention of maxillary complete dentures*, J. Prosthet. Dent., 1978 Aug, 40(2), 131–136.
- [9] MÁRTON K., BOROS I., FEJERDY P., MADLENA M., *Evaluation of unstimulated flow rates of whole and palatal saliva in healthy patients wearing complete dentures and in patients with Sjögren's syndrome*, J. Prosthet. Dent., 2004, 91, 577–581.
- [10] MIYAWAKI S., KATAYAMA A., TANIMOTO Y., ARAKI Y., FUJII A., YASHIRO K., TAKANO-YAMAMOTO T., *Salivary flow rates during relaxing, clenching, and chewing-like movement with maxillary occlusal splints*, Am. J. Orthod. Dentofacial. Orthop., 2004, 126, 367–370.
- [11] NAVAZESH M., CHRISTENSEN C.M., *A comparison of whole mouth resting and stimulated salivary measurement procedures*, J. Dent. Res., 1982, 61, 1158–1162.
- [12] NIEDERMEIER W.H., KRAMER R., *Salivary secretion and denture retention*, J. Prosthet. Dent., 1992 Feb, 67(2), 211–216.
- [13] OLSSON H., HENRICSSON V., SVENSSON A., AXELL T., *Evaluation of in vitro properties of films of saliva substitutes in contact with different surfaces. A comparative study with instruments for measurements of friction and rheologic properties*, Acta Odontol. Scand., 1995 Oct, 53(5), 334–338.
- [14] ORSTAVIK J.S., FLOYSTRAND F., *Retention of complete maxillary dentures related to soft tissue function*, Acta Odontol. Scand., 1984 Oct, 42(5), 313–320.
- [15] RANTONEN P.J., MEURMAN J.H., *Viscosity of whole saliva*, Acta Odontol. Scand., 1998 Aug, 56(4), 210–214.
- [16] WANG S.L., ZHAO Z.T., LI J., ZHU X.Z., DONG H., ZHANG Y.G., *Investigation of the clinical value of total saliva flow rates*, Arch. Oral. Biol., 1998 Jan, 43(1), 39–43.
- [17] WATANABE T., KOBAYASHI K., SUZUKI T., KUMAGAI H., ICHIKAWA K., KOBAYASHI K., KYU T., SATO I., NAGAO M., *Development of a recording system for saliva pH with a complete denture by telemetry*, Arch. Oral. Biol., 1997, Vol. 42, No. 3, 251–253.
- [18] WOLFF A., OFER S., RAVIN M., HELFT M., CARDASH H.S., *The flow rate of whole and submandibular/sublingual gland saliva in patients receiving replacement complete dentures*, J. Oral. Rehabil., 2004 Apr, 31(4), 340–343.
- [19] YEH C.K., JOHNSON D.A., DODDS M.W., SAKAI S., RUGH J.D., HATCH J.P., *Association of salivary flow rates with maximal bite force*, J. Dent. Res., 2000, 79, 1560–1565.
- [20] YURDUKORU B., TERZIOGLU H., YILMAZ T., *Assessment of whole saliva flow rate in denture wearing patients*, J. Oral. Rehabil., 2001 Jan, 28(1), 109–112.